

## Power Recliner Armchair

# Assembly Manual

## ME7A6073

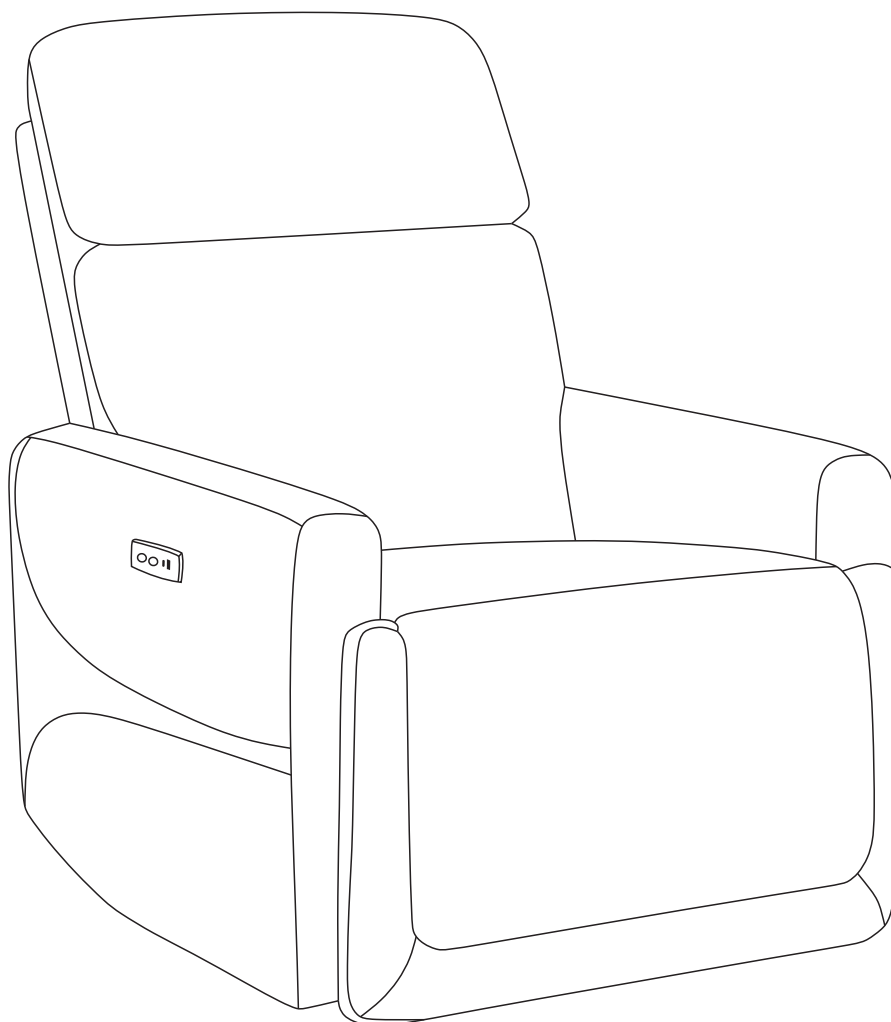
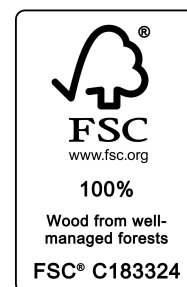

**⚠ CAUTION** THIS ASSEMBLY MANUAL CONTAINS IMPORTANT SAFETY INFORMATION.  
PLEASE READ AND KEEP FOR FUTURE REFERENCE.

---

## COMPONENTS

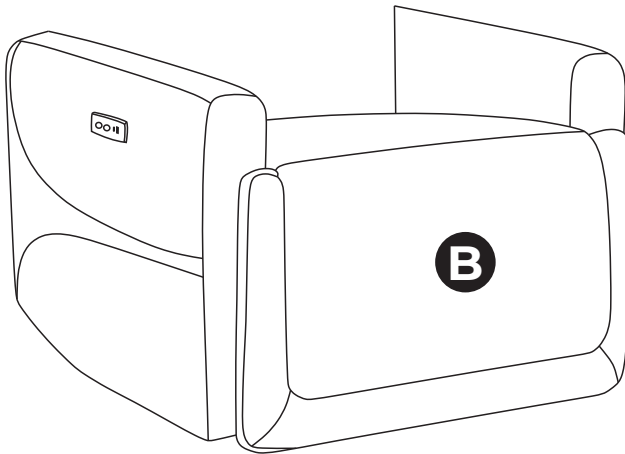
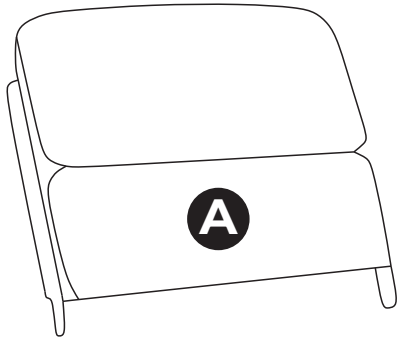

**A** Chair Back  
1X

**B** Chair Base  
1X

**C** Power Cord  
1X

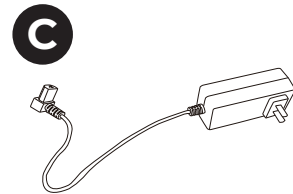

## WARNING

Find a yellow protector at the bottom, then remove it before using.

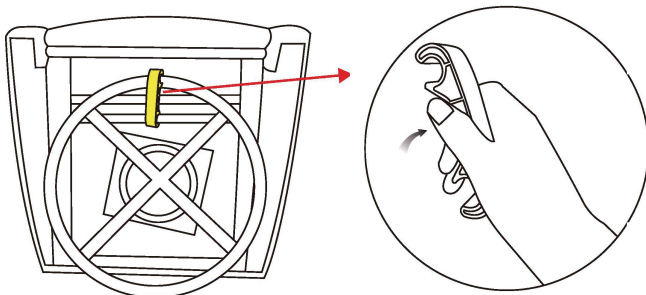

## Before you begin

Locate the Power Cord (C) at the bottom of the chair.

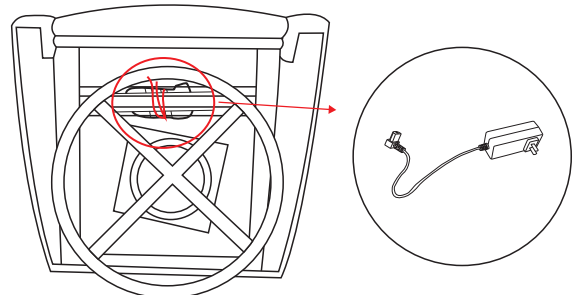

## ASSEMBLY INSTRUCTIONS

1

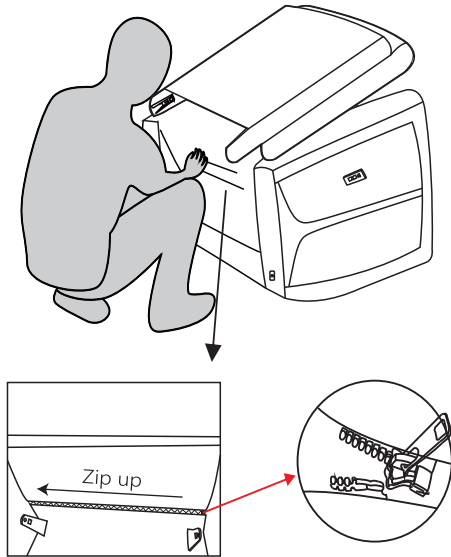

Zip up the bottom of the back and the seat together.

2

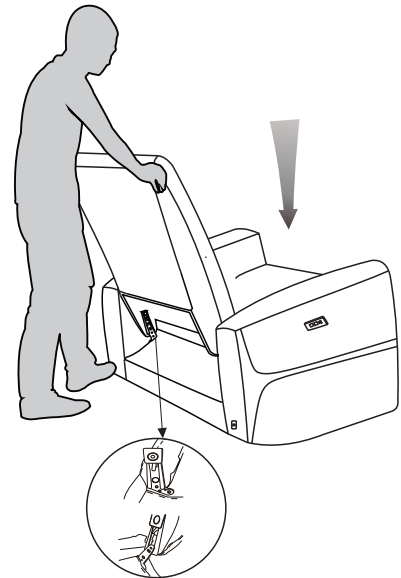

Slide the Backrest into the metallic quick connectors of the Seat. Push down the Backrest firmly until each side is locked into place and an audible “click” is heard.

3

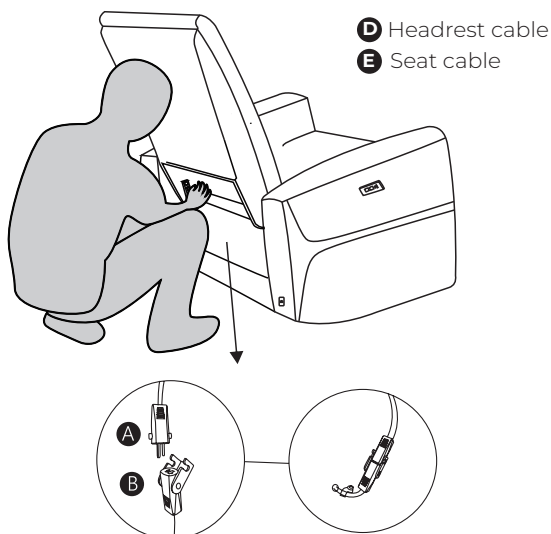

Connect the cable D into cable E.

4

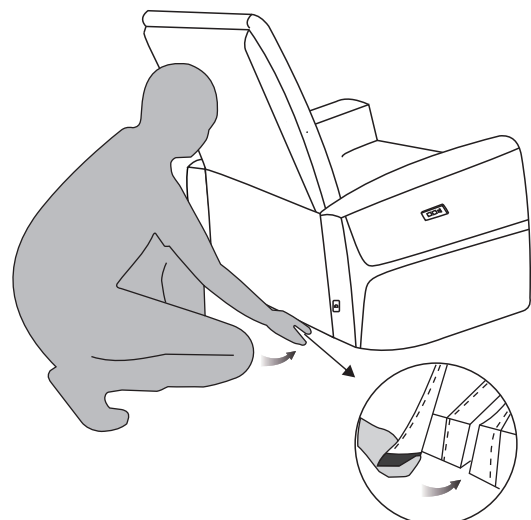

Attach the back cover to the bottom of the seat with Velcro.

## ASSEMBLY INSTRUCTIONS

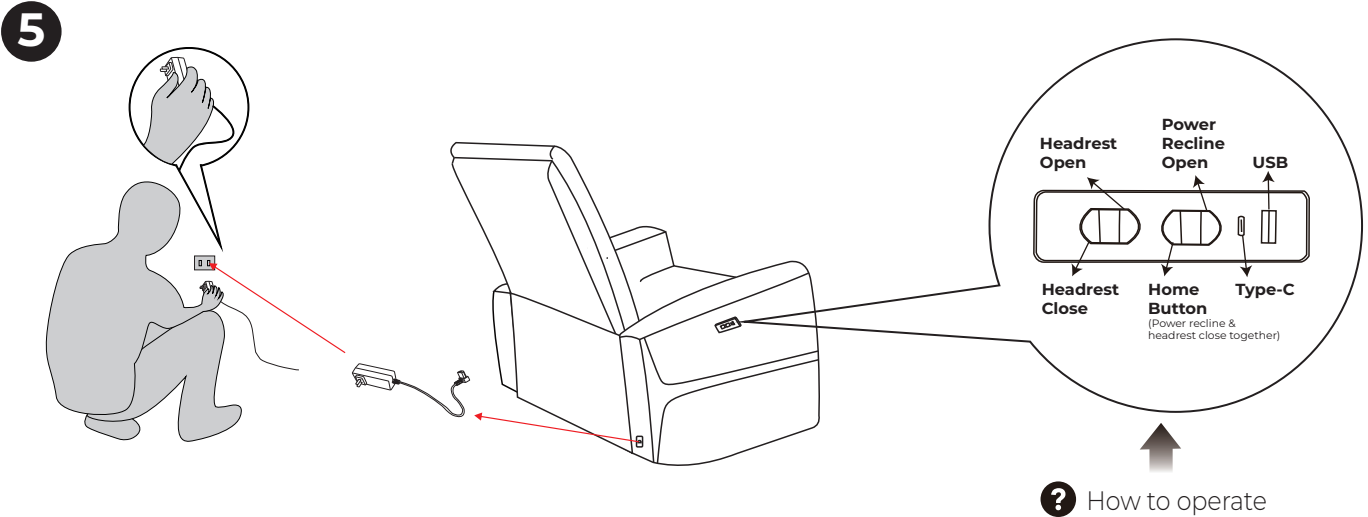

Connect one end of the power cord into the DC adaptor located at the back corner of the seat. Plug the other end of power cord into the power outlet. Note: After all the connections are made, the green LED will be lit up.

## POWER CONNECTIONS

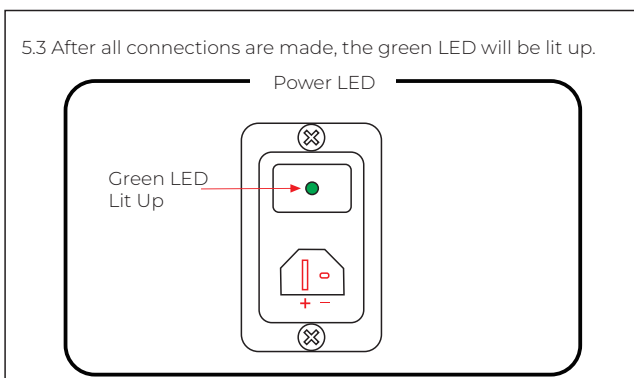
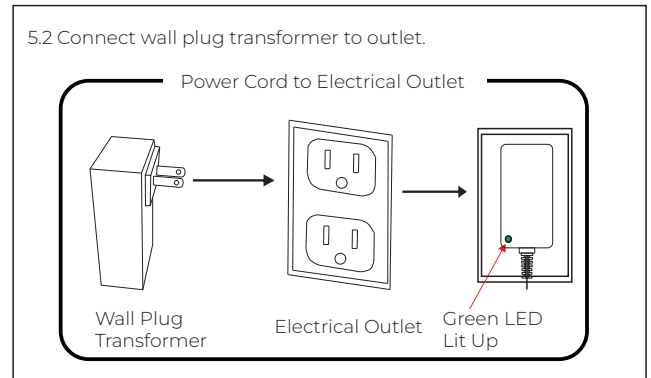
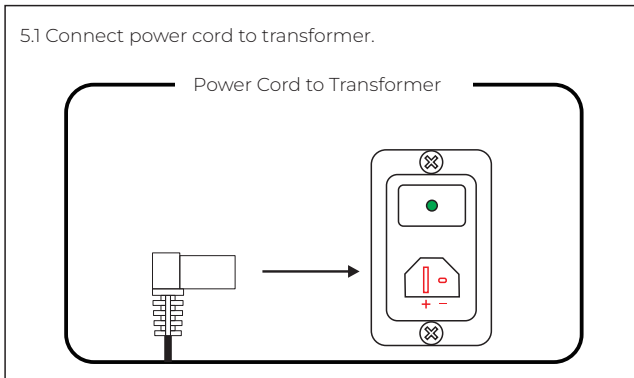

## PRODUCT WARRANTY

- 1-year limited on cover against splitting, peeling, and/or tearing.
- 1-year limited on internal and external frame structure.
- 1-year limited on cushioning material, seat springs and mechanism.

## CARE & MAINTENANCE

Blot and spot clean immediately with a clean, absorbent cloth and a water-free stain remover (Cleaning Code: S).

## Follow Us

 @chitalivingofficial

 @chitaliving

 @chitaliving

 @chitaliving

---

If at any step you need a helping hand, we're always here for you. You can email us, or hop into a live chat on our website - whatever method is convenient for you.

 [support@chitaliving.com](mailto:support@chitaliving.com)