

BS71200D Assembly Manual

Accent Chair & Ottoman







CAUTION

THIS ASSEMBLY MANUAL CONTAINS IMPORTANT SAFETY INFORMATION.

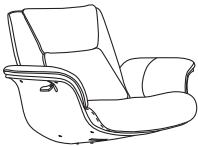
PLEASE READ AND KEEP FOR FUTURE REFERENCE.

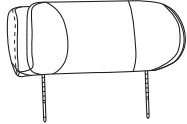
Box 1 :

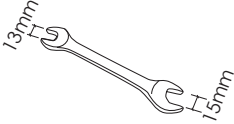
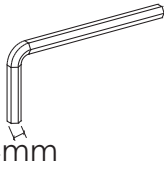
<p>B1×1</p>  <p>Chair Body</p>	<p>B2×1</p>  <p>Ottoman Body</p>	<p>C1×1</p>  <p>Headrest</p>
<p>H1×4</p>  <p>(Note: Locknuts should be removed from the bottom of Chair Body)</p> <p>Locknut (M8mm)</p>	<p>H2×4</p>  <p>Bolt (M6x25mm)</p>	<p>T1×1</p>  <p>Wrench</p>
<p>T2×1</p>  <p>Allen Wrench (M4)</p>		

Box 2 :

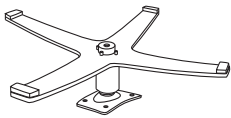
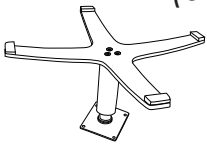
<p>A1×1 (Large)</p>  <p>Chair Base</p>	<p>A2×1 (Small)</p>  <p>Ottoman Base</p>	
---	---	--

Before you begin:

1. Check if you have received all parts using the diagram on this page. Do not start the assembly process until all parts are present. If you have not received all parts or received wrong or damaged ones, please contact our customer service at support@chitaliving.com and we will get back to you.
2. Do not discard any of the packaging until you are certain that you have all the necessary parts for the assembly.
3. Do NOT use power tools for assembly.

ASSEMBLY INSTRUCTIONS

- 1 Unpack and place the Chair Body (B1) on a soft, clean surface. Remove the Locknuts (H1) from the bottom of the Chair Body (B1) using Wrench (T1).

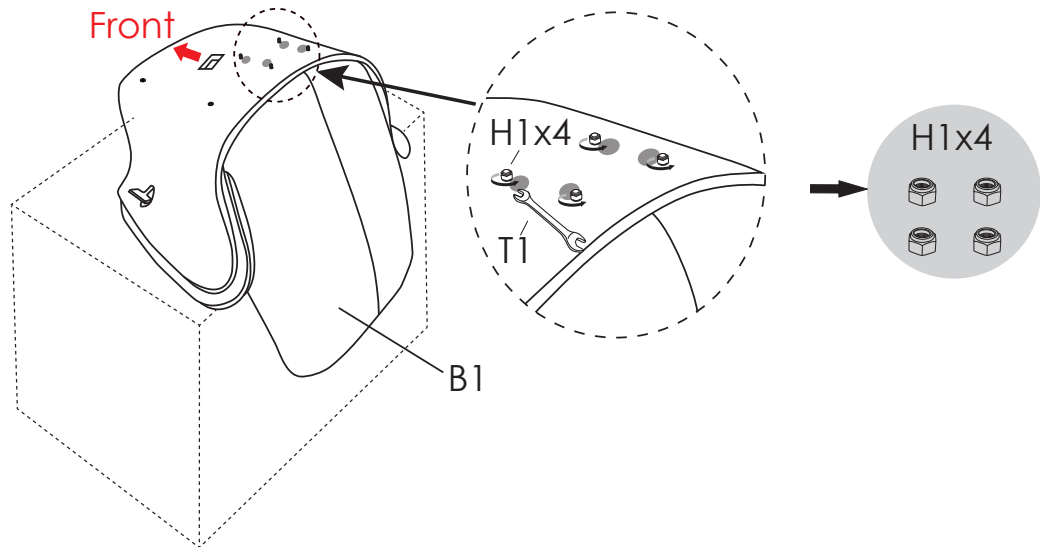

- 2 Attach the Chair Base (A1) to the Chair Body (B1) using Locknuts (H1) from Step 1 and Wrench (T1).

Note: Please pay attention to the direction of the Chair Base (A1). The higher end of the metal plate on the Chair Base (A1) should face the front of the chair and the lower end should face the back.

Note: Do NOT use power tools for assembly.

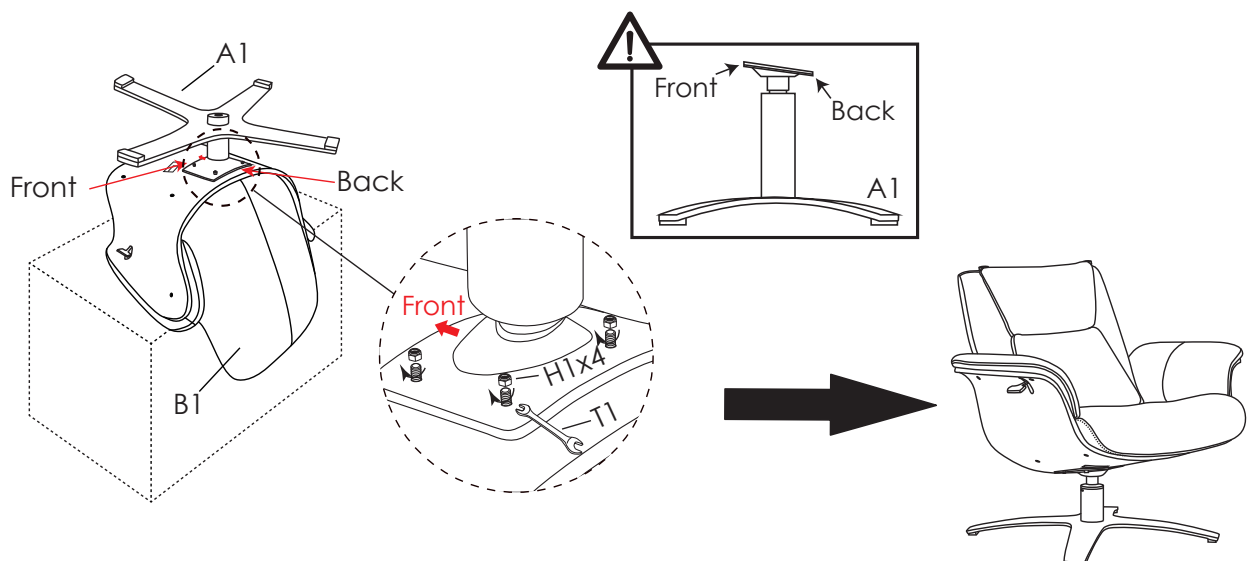

- 3** Insert the Headrest (C1) into the Chair Body (B1).

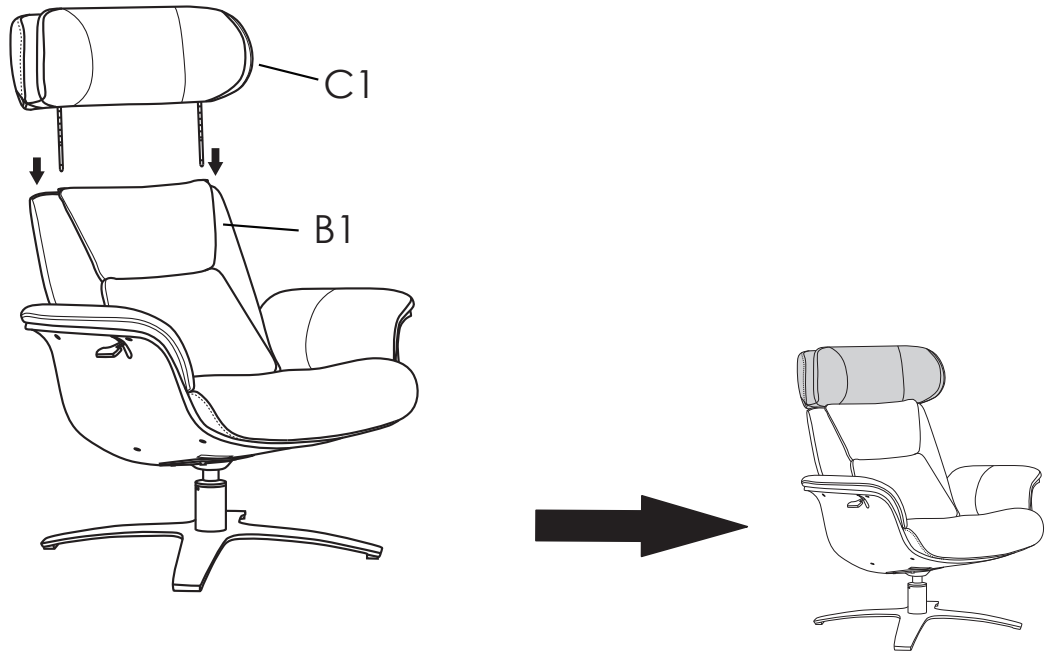

- 4** Unpack and place the Ottoman Body (B2) on a soft, clean surface. Attach the Ottoman Base (A2) to the Ottoman Body (B2) using Bolts (H2) and Allen Wrench (T2).

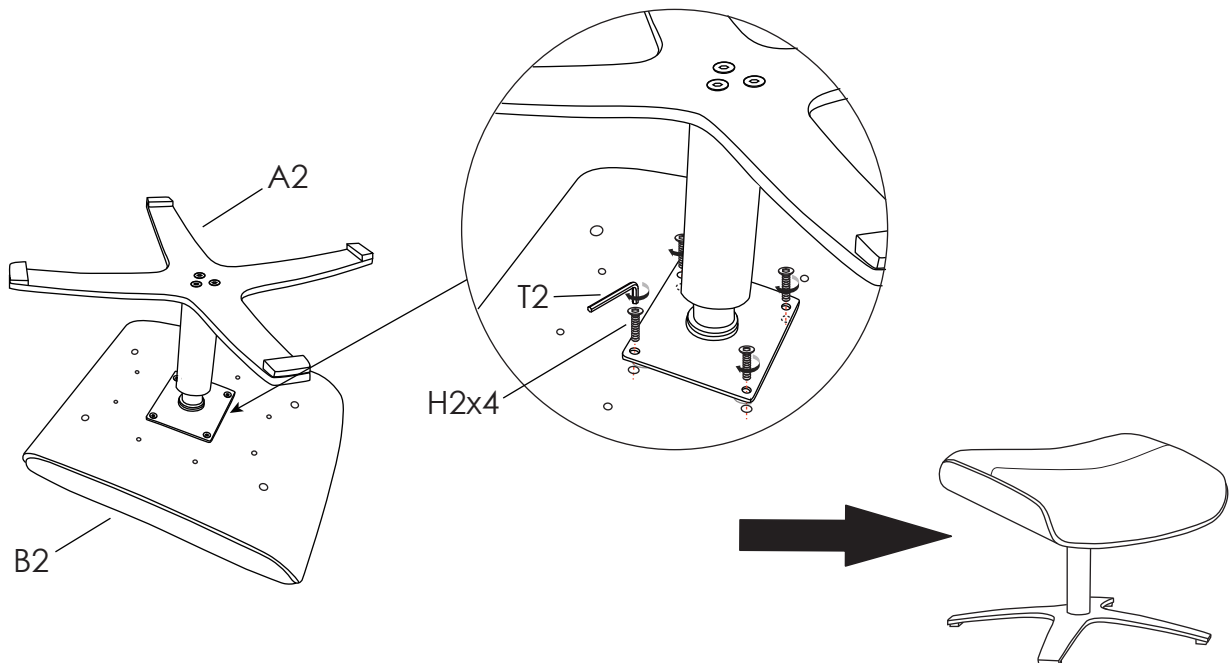

5 Assembly complete. Enjoy.

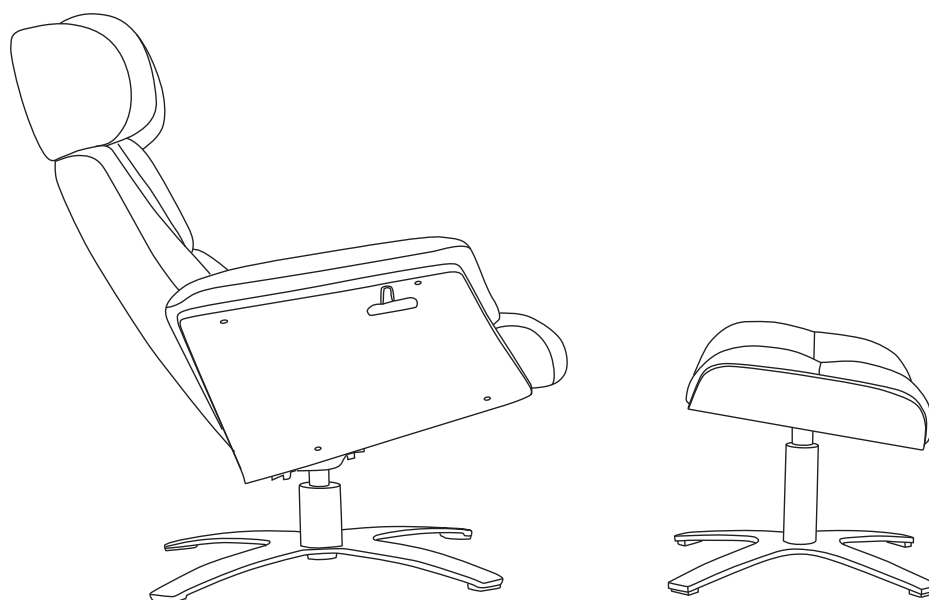

How to adjust the headrest?

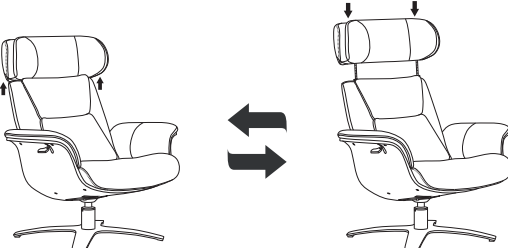

- Lift or lower the headrest to accommodate different heights.



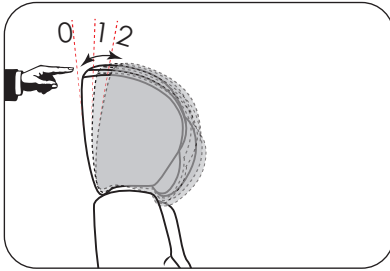

- The headrest has 3 different positions: Position 0 (original position), Position 1, Position 2. Push the headrest forward slightly to get to Position 1 and Position 2.

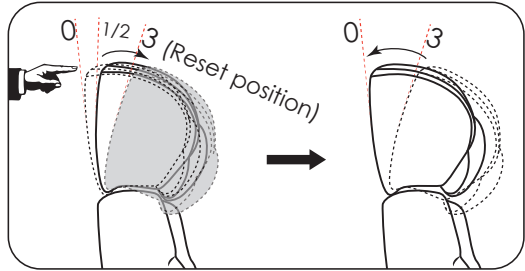

- Reset: Push the headrest further forward to Position 3, the headrest will then be released to Position 0.

How to adjust the backrest?

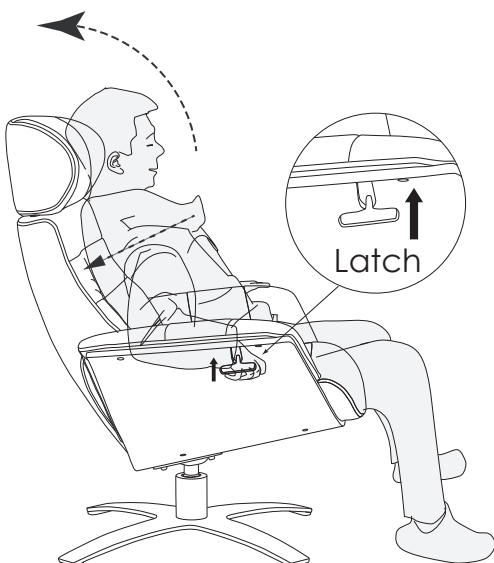

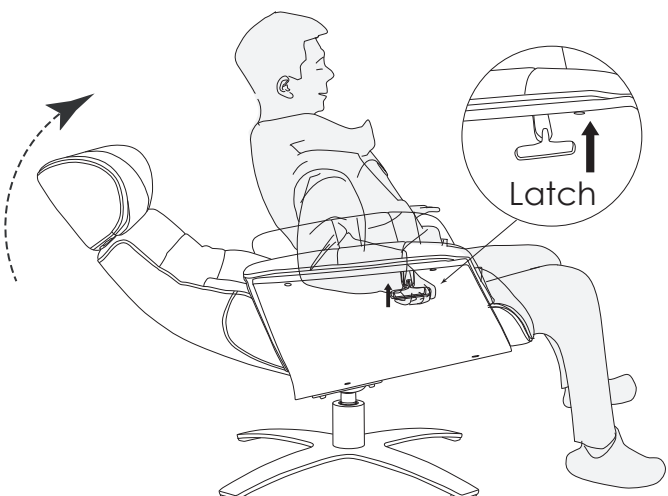

1) From **Upright Position** to **Fully Reclined Position**:
Lift the latch to recline.

2) From **Fully Reclined Position** to **Upright Position**:
Sit up slightly. Lift the latch and the backrest will move forward to upright position.

PRODUCT WARRANTY

- 1-year limited on cover against splitting, peeling, and/or tearing.
- 1-year limited on internal and external frame structure.
- 1-year limited on cushioning material, seat springs and mechanism.

CARE & MAINTENANCE

Water Based Cleaner 'W': Spot clean using the foam only from a water-based cleaning agent such as a mild detergent or non-solvent upholstery shampoo product. Apply foam with a soft in circular motion.

Vaccum when dry.

Do not place furniture in direct sunlight and keep furniture at least 60 cm / 2 feet from heat sources to avoid fading.

Follow Us



@chitalivingofficial



@chitaliving



@chitaliving



@chitaliving

If at any step you need a helping hand, we're always here for you. You can email us, or hop into a live chat on our website - whatever method is convenient for you.



support@chitaliving.com