

Assembly Manual

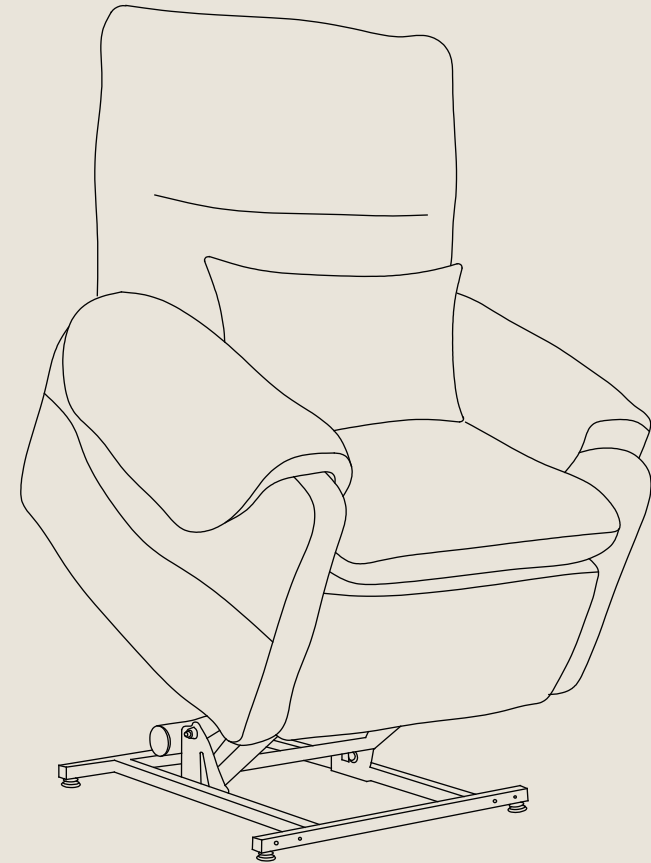

Coro Power Lift Chair with Massage







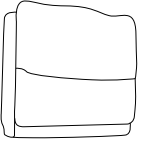
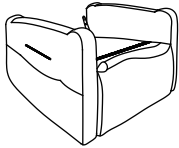
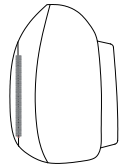
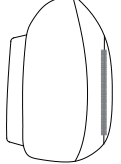
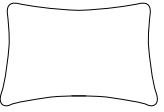

If at any step you need a helping hand, we're always here for you.

Thank you for purchasing. Please read this manual carefully before using and keep this manual for future reference. The design and/or specification of this product is subject to change without notice.

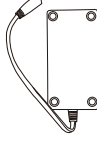
Count parts before assembling.

| | | | |
|---|---|---|---|
| A 1pc | B 1pc | C 1pc | D 1pc |
|  |  |  |  |
| Backrest | Seat | Left Arm Pillow | Right Arm Pillow |
| E 1pc | F 1pc | | |
|  |  | | |
| Lumbar Pillow | Seat Cushion | | |

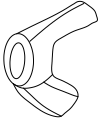
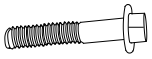
| | | | |
|---|---|---|--|
| G 1pc | H 1pc | I 1pc | J 1pc |
|  |  |  |  |
| Remote Control for Lifting & Reclining | Remote Control for Massage | Power Adapter | Power Cord for Massage |
| K 1pc | L 2pc | M 4pc | N 4pc |
|  |  |  |  |
| Power Cord for Adapter | Foot | Butterfly Nut | Bolt |

Step 1

Flip the chair to take out the compressed Left Arm Pillow (C), Right Arm Pillow (D) and Lumbar Pillow (E) from the bottom of the Seat (B). Then, cut the vacuumed bag carefully to take out the pillows.

Cut the plastic ties to take out the hardware pack (Includes: Remote Control for Lifting & Reclining, Remote Control for Massage, Power Adapter, Power Cord for Massage, Power Cord for Adapter, 2 pieces of Feet, 4 pieces of Butterfly Nuts, 4 pieces of Bolts).

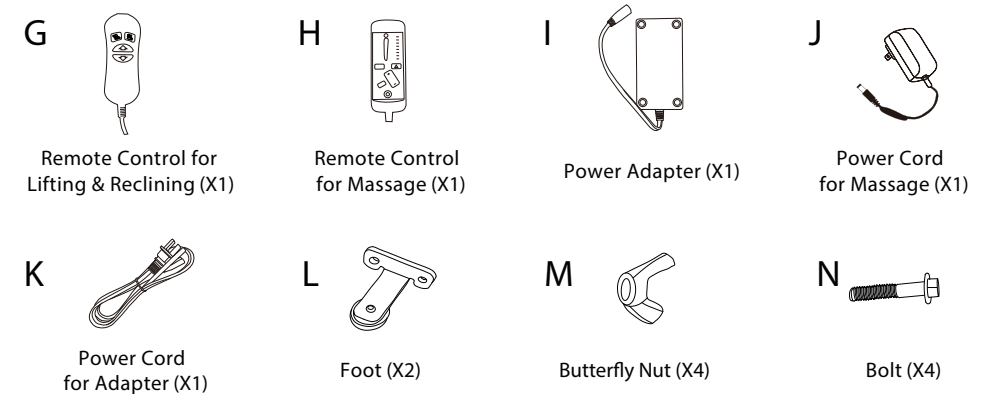
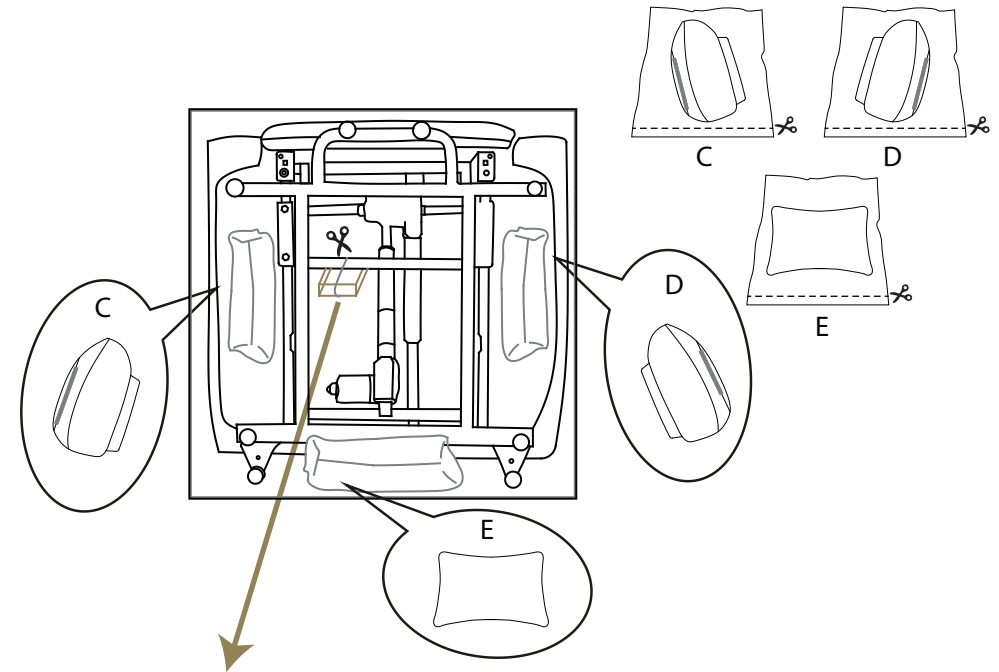

Step 2

Locate the four holes at the back of the seat base and attach the feet (L) using Bolts (N) and Butterfly Nuts (M). Fully tighten.

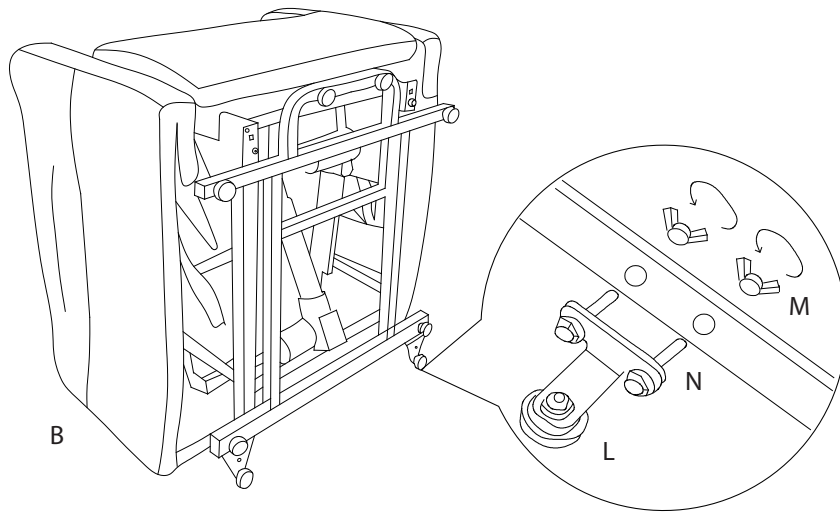

Step 3

Zip up the Left Arm Pillow (C) and Right Arm Pillow (D) to the left and right armrests. Then, attach the flaps of the arm pillows with Velcro.

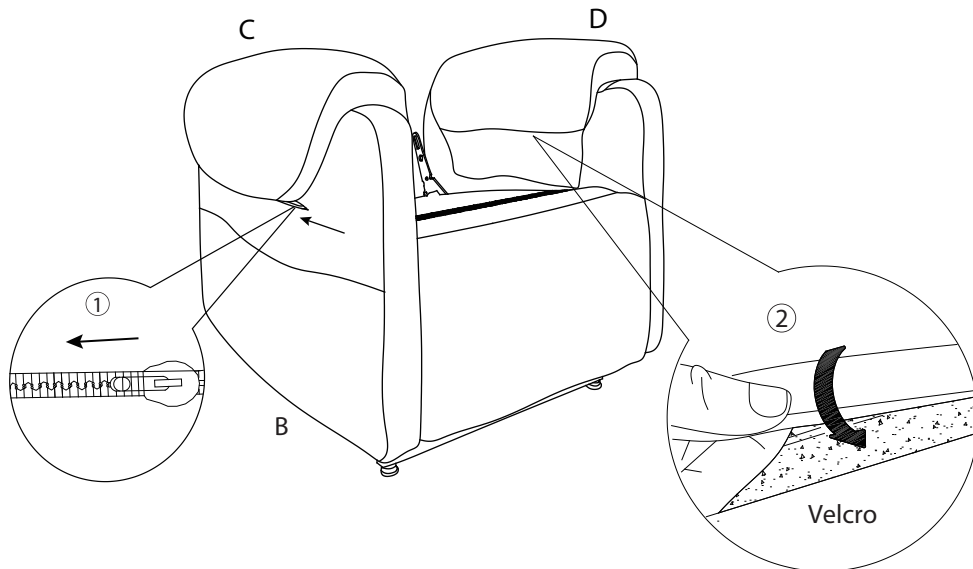

03

Step 4

Attach the Seat Cushion (F) to the Seat (B) with Velcro. Please note the massage wires should face the back of the chair. Then, attach the flap of Seat Cushion (F) to Seat Base (B) with Velcro.

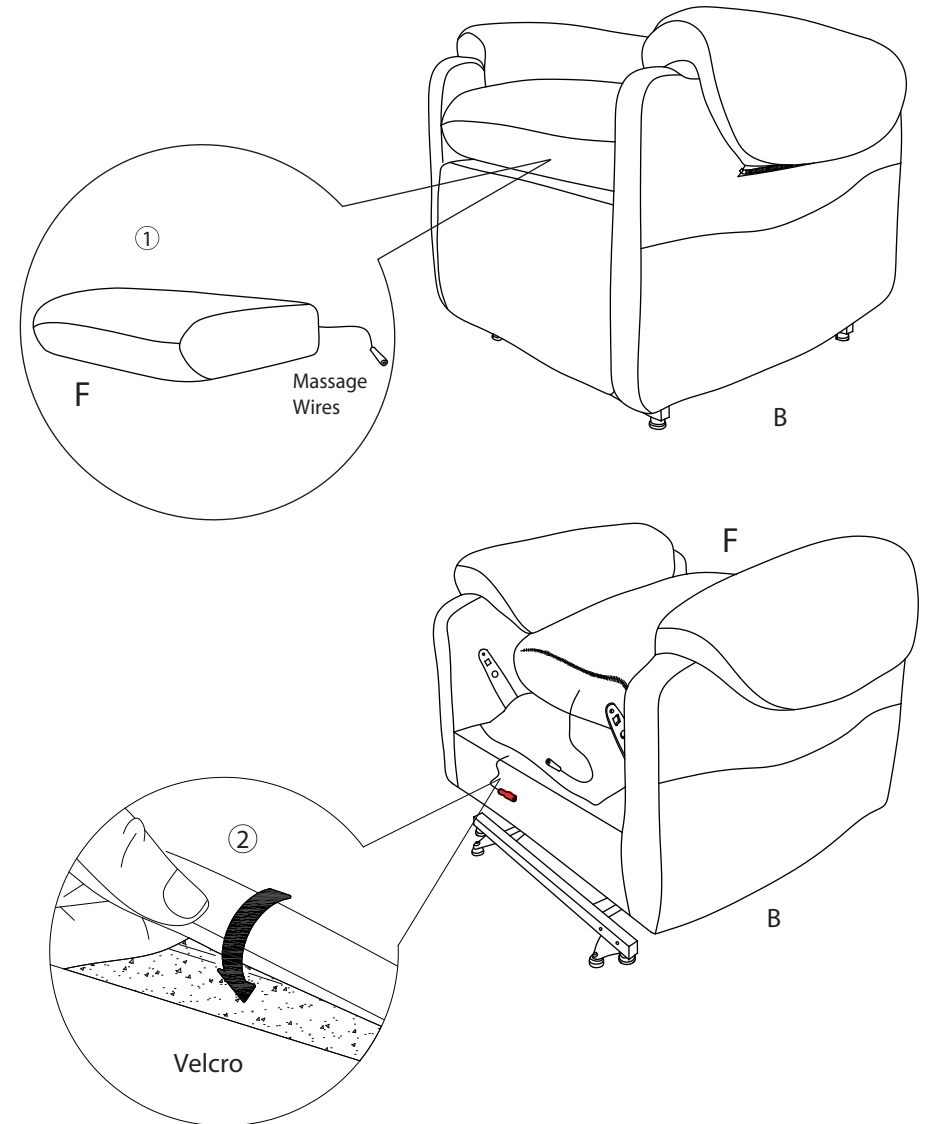

04

Step 5

Zip up the bottom of the Backrest (A) and the Seat (B) together.

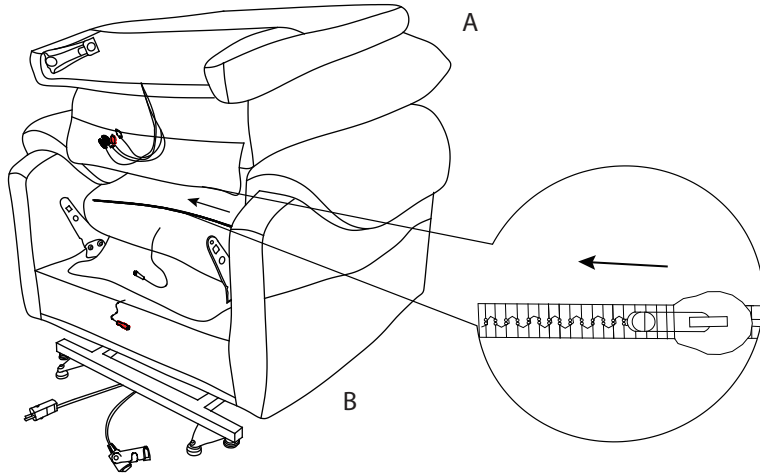

Step 6

Slide the Backrest (A) into the metallic quick connectors of the Seat (B). Push down the back firmly until each side is locked into place and an audible “click” is heard.

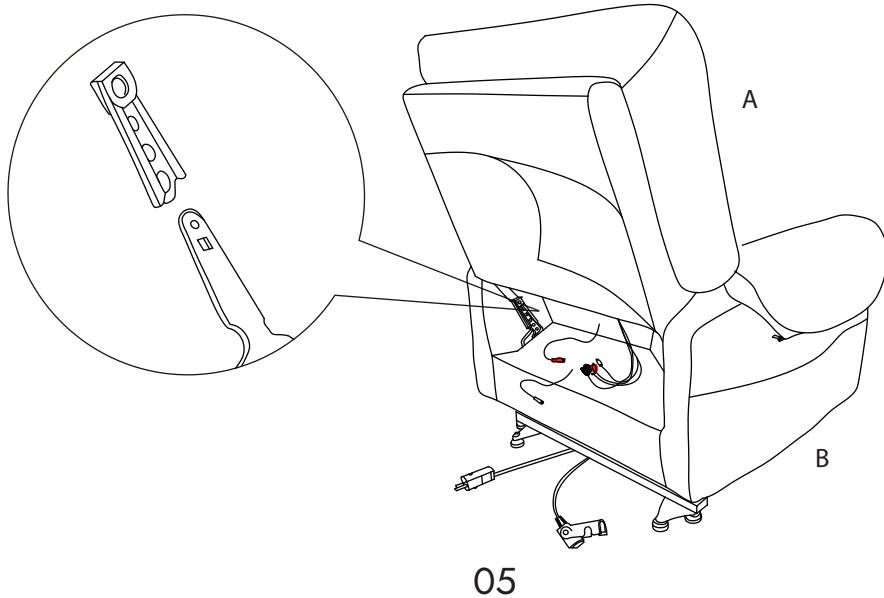

Step 7

Connect the white and red wires from the Backrest (A) to the corresponding wires on the Seat (B). Make sure the corresponding colors match (white with white & red with red).

Locate the Remote Control for Massage (H) and connect to its corresponding receiver on the backrest. Make sure the corresponding sizes match.

Locate the Power Cord for Massage (J) and connect to its corresponding receiver on the backrest. Make sure the corresponding sizes match.

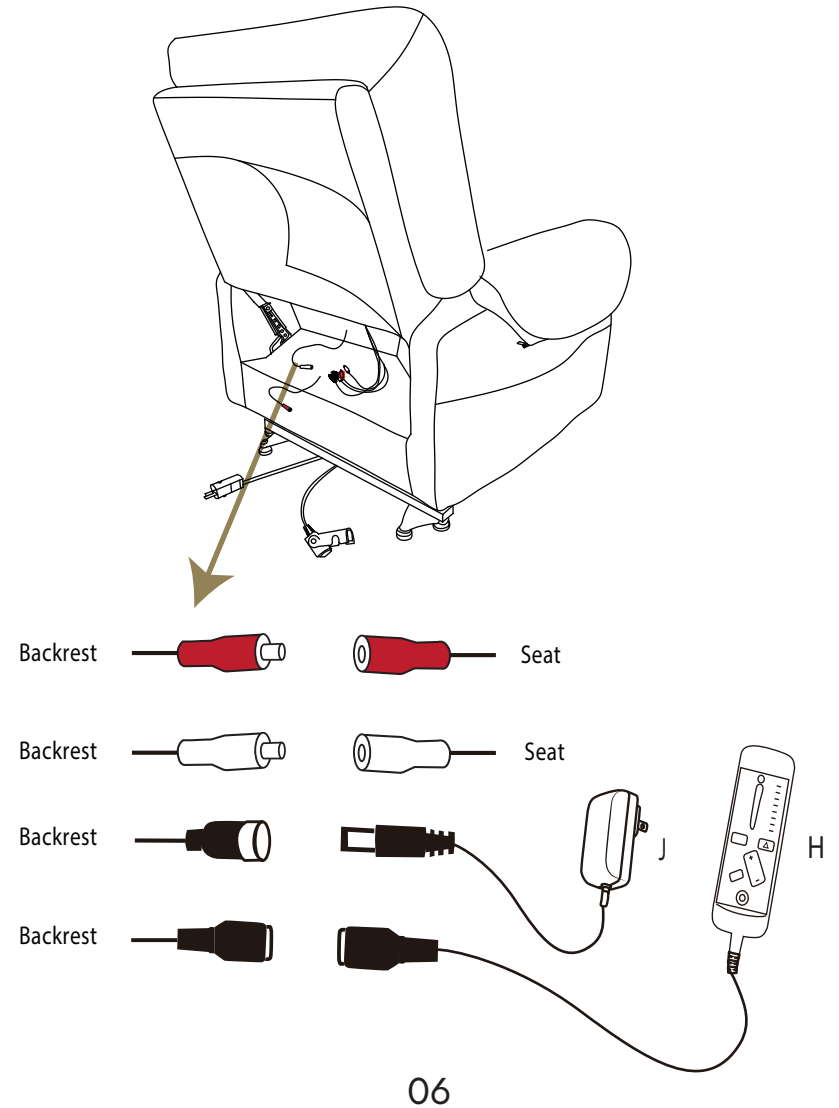

Step 8

Locate the Remote Control for Lifting & Reclining (G) and connect to its corresponding receiver on the base of the seat.

Locate the Power Adapter (I) and connect to its corresponding receiver on the base of the seat.

Connect one end of the Power Cord for Adapter (K) into the Power Adapter (I).

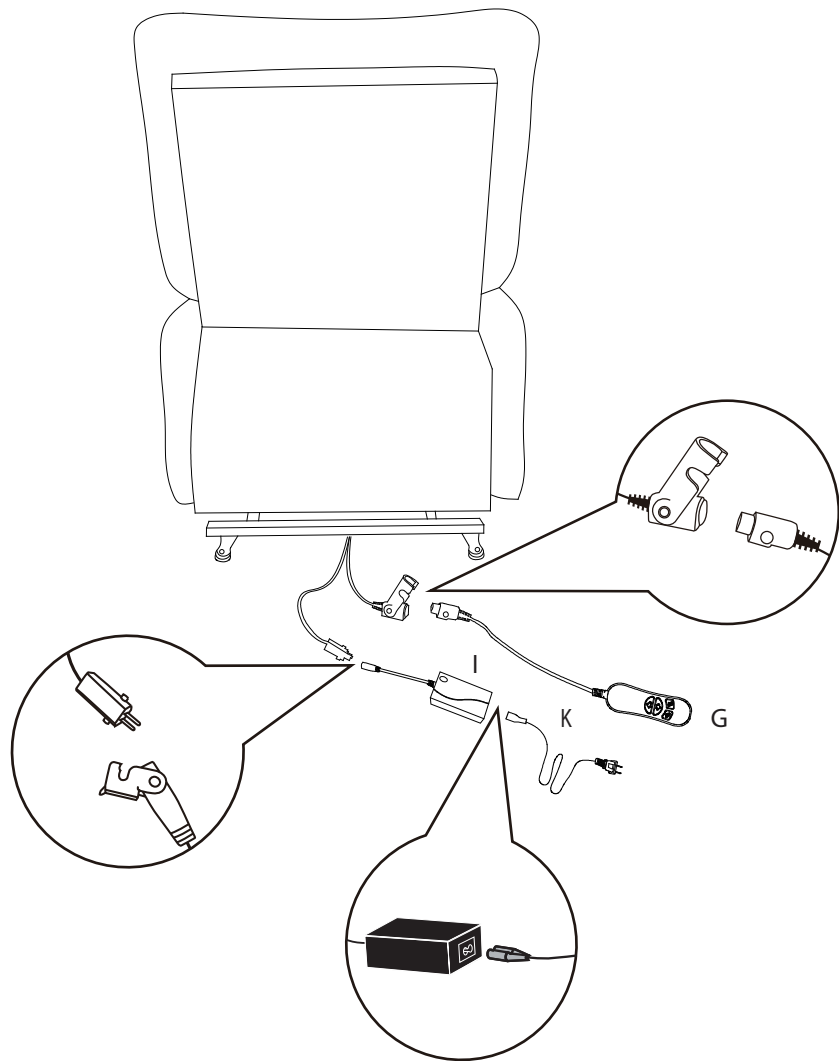

07

Step 9

Attach the back cover to the bottom of the seat with Velcro.

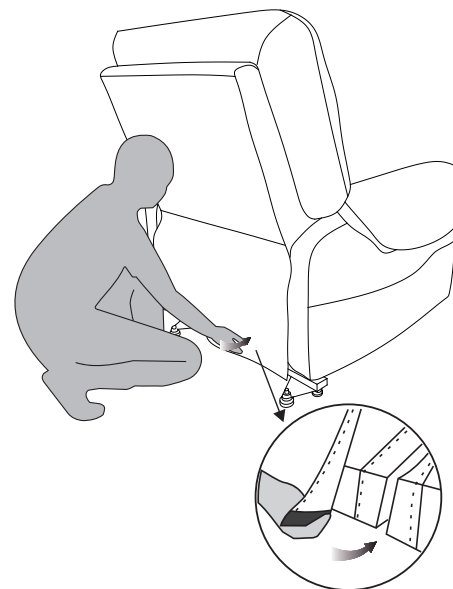

Step 10

Plug Power Cord for Adapter (K) into the power outlet.

Note: After all the connections are made, the green LED on Power Adapter (I) will be lit up.

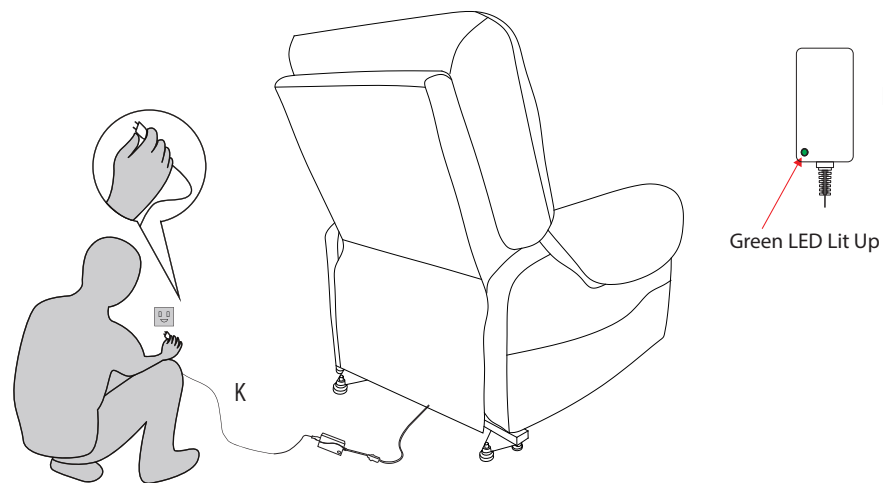

08

Step 11

Place the Lumbar Pillow (E) on the seat and enjoy your new piece of furniture.

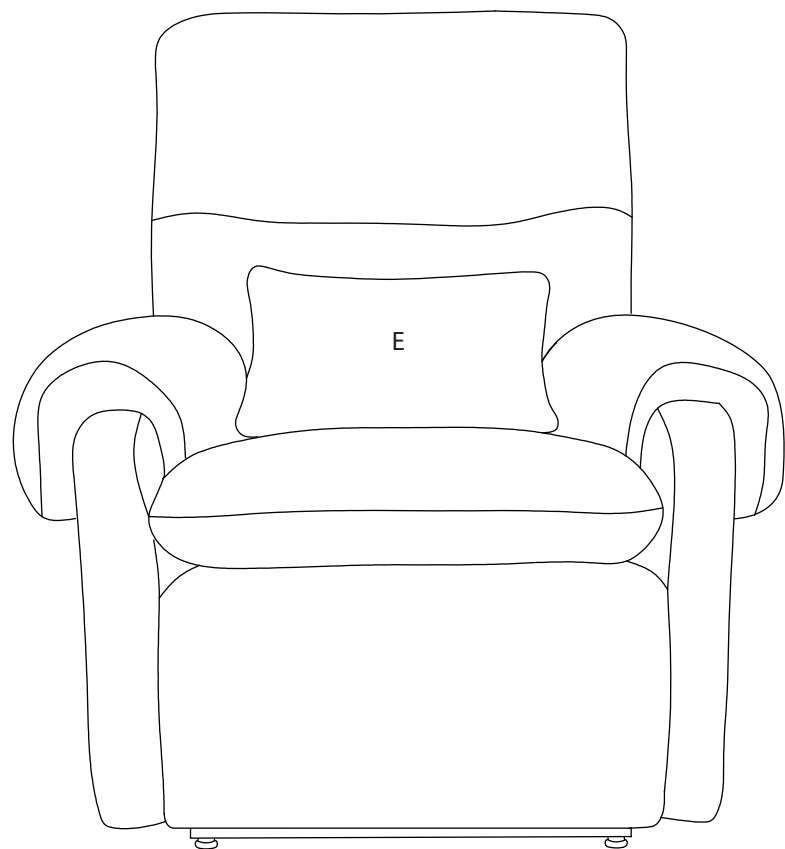

How to Operate

Remote Control for Lifting & Reclining

Press and hold to recline the back.

Press and hold to lower the footrest.
Continue to press to raise the lift chair
to standing position.

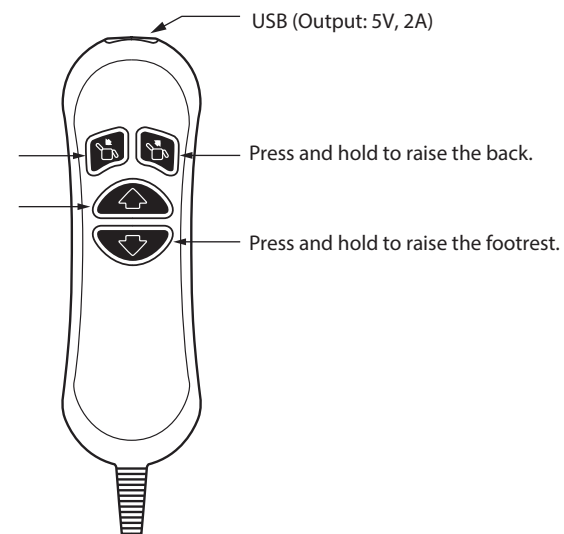

Remote Control for Massage

Massage Zone Selection

Heat

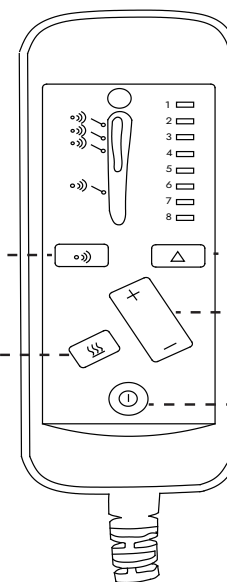

8 Massage Modes

Massage Intensity

Massage On/Off