

CHITA®

# CHITA® Assembly Manual

Liam Collection

Modular Sofa

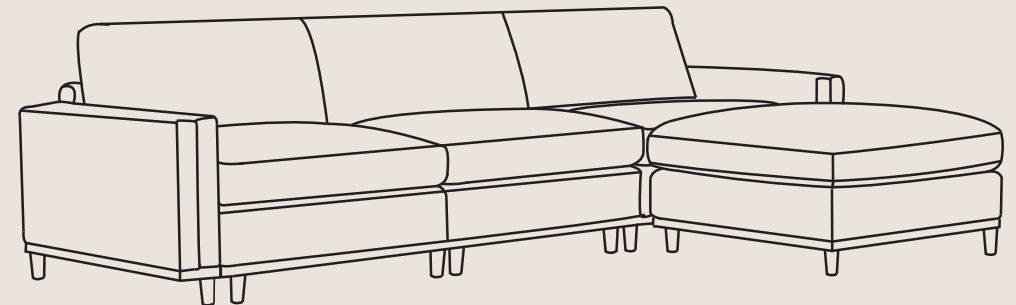

## Follow Us

 @chitalivingofficial

 @chitaliving

 @chitaliving

 @chitaliving

If at any step you need a helping hand, we're always here for you. You can email us, or hop into a live chat on our website — whatever method is convenient for you.

 [support@chitaliving.com](mailto:support@chitaliving.com)

Thank you for purchasing from CHITA LIVING. Please read this manual carefully before using and keep this manual for future reference.

The design and /or specification of this product is subject to change without notice.

# Welcome to CHITA LIVING

If you are reading these instructions, the hard part is already out of the way. Surrounded by all these boxes, you may feel a little overwhelmed. No worries, we will walk you through and you will find the assembly process easy, intuitive and mostly, fun. Here are some tips before you get started.













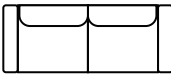



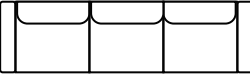



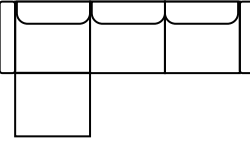





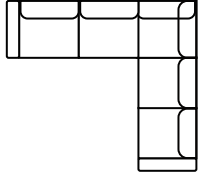



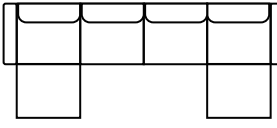

1. Count the boxes. Check if you have received all boxes using the diagram on next page. Do not start the assembly process until all boxes are present. If you have not received all boxes or received wrong boxes, please contact our customer service at [support@chitaliving.com](mailto:support@chitaliving.com) and we will get back to you. Do not discard any of the packaging until you are certain that you have all the necessary parts for the assembly.

2. Do not open all boxes at once. Start with Arms Box and Left Chair Seat & Backrest Box to assemble the Left Armchair. Then, move on to open the Right Chair Seat & Backrest Box to assemble the Right Armchair. Next, assemble the Armless Chair, Corner, and finally, the Ottoman.

3. After the assembly is complete, feel free to enjoy your Liam Collection as much as you can. However, please ensure that the packaging is disposed of in a safe and environmentally responsible way.

4. For your safety (as well as Liam's), do not sit on the backrest during and after assembly and never use this sofa as a step ladder.

**!** Do not start the assembly process until all boxes are present.

<p><b>2-piece Armless</b></p> 	<p>Box × 2</p>   <p>Armless Chair      Armless Chair</p>
<p><b>2-piece Sofa</b></p> 	<p>Box × 3</p>    <p>Arms      Left Chair Seat &amp; Backrest      Right Chair Seat &amp; Backrest</p>
<p><b>3-piece Sofa</b></p> 	<p>Box × 4</p>     <p>Arms      Left Chair Seat &amp; Backrest      Right Chair Seat &amp; Backrest      Armless Chair</p>
<p><b>4-piece Modular</b></p> 	<p>Box × 5</p>      <p>Arms      Left Chair Seat &amp; Backrest      Right Chair Seat &amp; Backrest      Armless Chair</p> <p>Ottoman</p>
<p><b>5-piece Corner Modular</b></p> 	<p>Box × 7</p>        <p>Arms      Left Chair Seat &amp; Backrest      Right Chair Seat &amp; Backrest      Armless Chair</p> <p>Armless Chair      Corner Backs      Corner Seat &amp; Cushions</p>
<p><b>6-piece Modular</b></p> 	<p>Box × 7</p>        <p>Arms      Left Chair Seat &amp; Backrest      Right Chair Seat &amp; Backrest      Armless Chair</p> <p>Armless Chair      Ottoman      Ottoman</p>

# Assembly Manual

## Left Armchair



### Parts

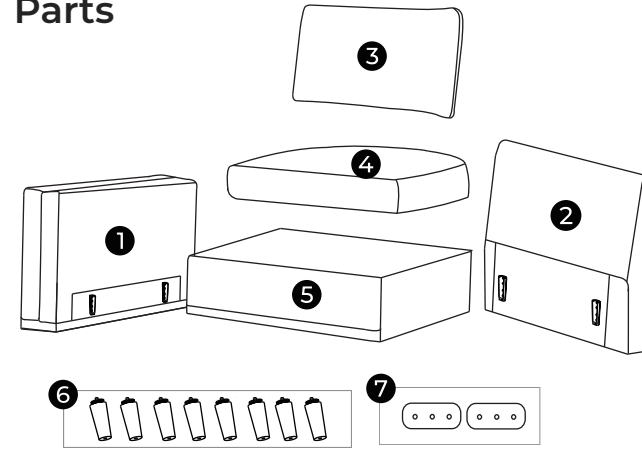

- 1 Left Arm
- 2 Left Backrest
- 3 Back Cushion
- 4 Seat Cushion
- 5 Left Seat Base
- 6 Leg x 8
- 7 Connector x 2

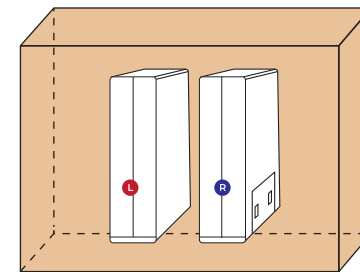

**Arms**  
PIECES INCLUDED

- 1 Left Arm x 1
- 2 Right Arm x 1
- 3 Assembly Manual x 1

**Note:** Left & Right Arms are packed together in Arms Box.

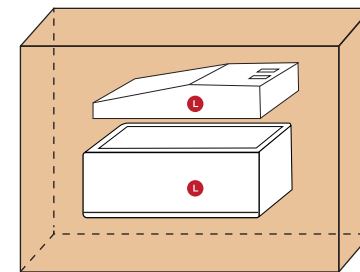

**Left Chair Seat & Backrest**  
PIECES INCLUDED

- 1 Left Seat Base x 1
- 2 Left Backrest x 1
- 3 Back Cushion x 1
- 4 Seat Cushion x 1
- 5 Leg x 8
- 6 Connector x 2

# Left Armchair

## Step 1

Take out the Left Arm (L) from Arms Box.

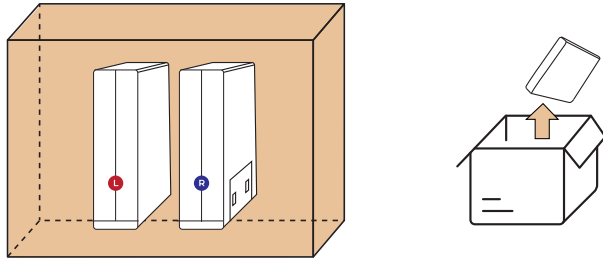

## Step 2

Take out the Left Seat and Backrest from Left Chair Seat & Backrest Box.

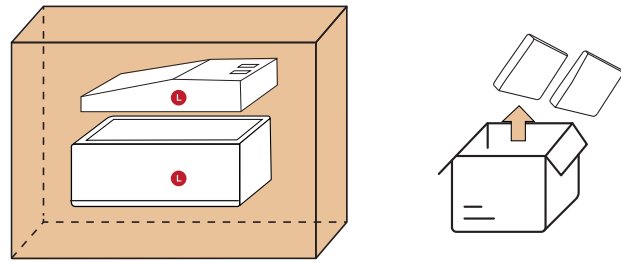

## Step 3

Remove the three wood sticks at the base of the seat to take out the hardware pack, vacuum-packed Seat Cushion and Back Cushion, then open these bags.

⚠ Remove the sticks one by one. Push the stick down and rotate it towards the corner of the base and pull it out. Do NOT use sharp tools such as knives or scissors to open bags as it could potentially damage the cushions. Please use your hands to gently pull the bags apart. Please allow up to 48 hours for the cushions to return to the original thickness.

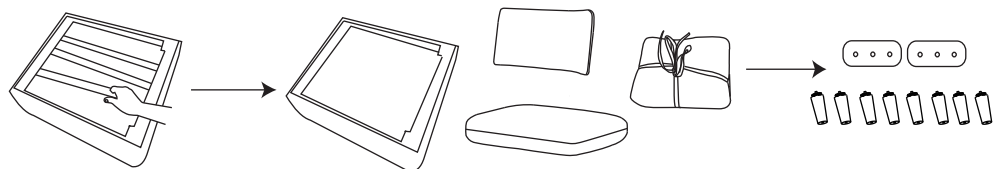

# Left Armchair

## Step 4

Rotate the Legs firmly.

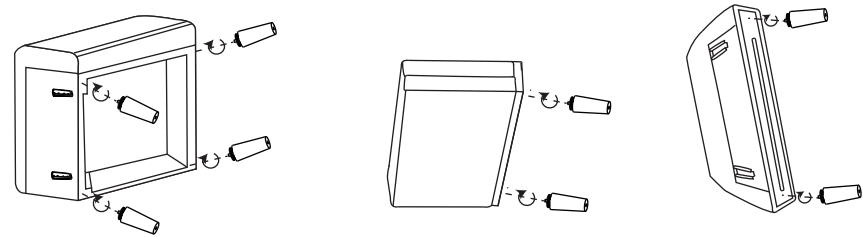

Left Seat

Left Arm

Left Backrest

## Step 5

Slide the Left Backrest into the Left Seat.

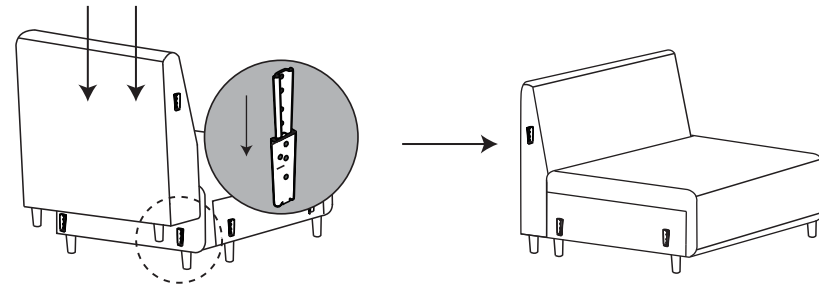

## Step 6

Slide the Left Arm into the Left Seat and Backrest.

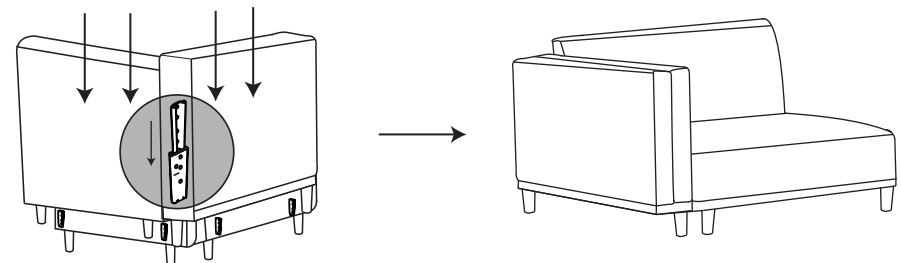

# Assembly Manual

## Left Armchair

### Step 7

Fluff the Seat Cushion and Back Cushion, and put them on the chair to complete the assembly of your Left Armchair.

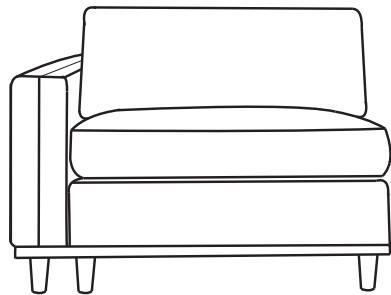

Congratulations!  
Left Armchair is ready!

### Tips

For now, please keep the Metal Connectors aside and you may need them after you have completed the assembly of all modules (See Page 21 to 23 for details).

# Assembly Manual

## Right Armchair



### Parts

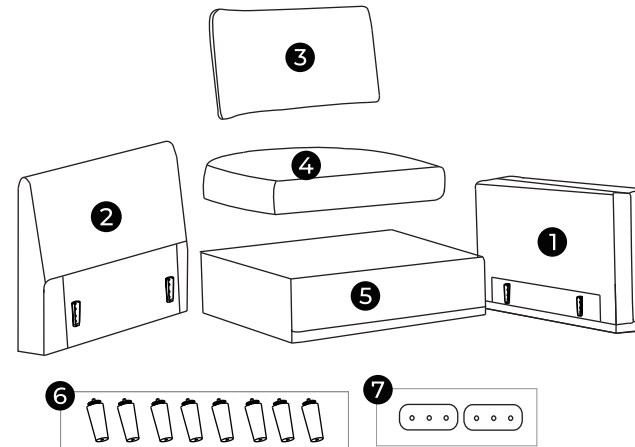

- 1 Right Arm
- 2 Right Backrest
- 3 Back Cushion
- 4 Seat Cushion
- 5 Right Seat Base
- 6 Leg x 8
- 7 Connector x 2

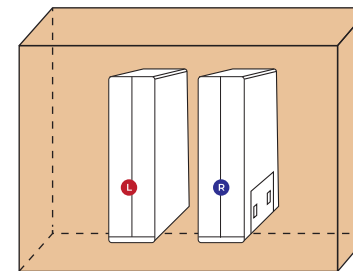

**Note:** Left & Right Arms are packed together in Arms Box.



### Arms PIECES INCLUDED

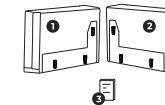

- 1 Left Arm x 1
- 2 Right Arm x 1
- 3 Assembly Manual x 1

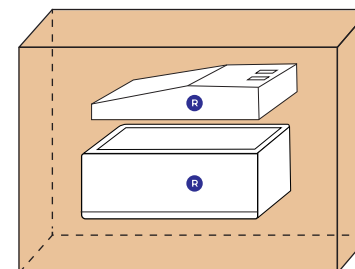

### Right Chair Seat & Backrest PIECES INCLUDED

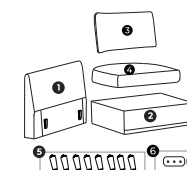

- 1 Right Seat Base x 1
- 2 Right Backrest x 1
- 3 Back Cushion x 1
- 4 Seat Cushion x 1
- 5 Leg x 8
- 6 Connector x 2

# Right Armchair

## Step 1

Take out the Right Arm (R) from Arms Box.

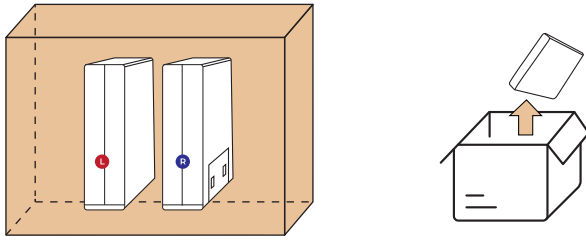

## Step 2

Take out the Right Seat and Backrest from Right Chair Seat & Backrest Box.

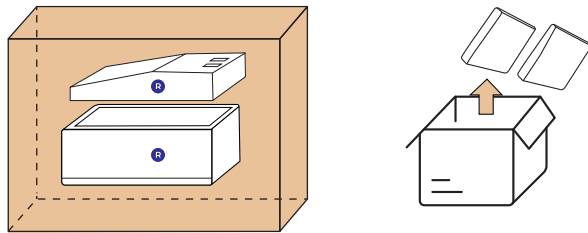

## Step 3

Remove the three wood sticks at the base of the seat to take out the hardware pack, vacuum-packed Seat Cushion and Back Cushion, then open these bags.

⚠ Remove the sticks one by one. Push the stick down and rotate it towards the corner of the base and pull it out. Do NOT use sharp tools such as knives or scissors to open bags as it could potentially damage the cushions. Please use your hands to gently pull the bags apart. Please allow up to 48 hours for the cushions to return to the original thickness.

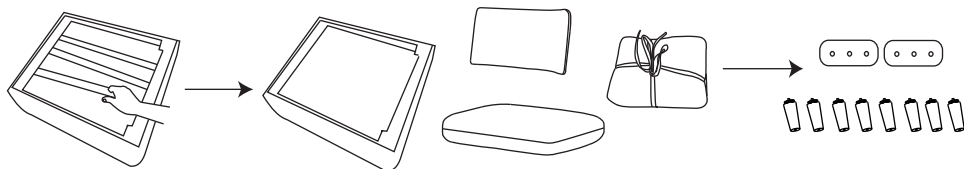

# Right Armchair

## Step 4

Rotate the Legs firmly.

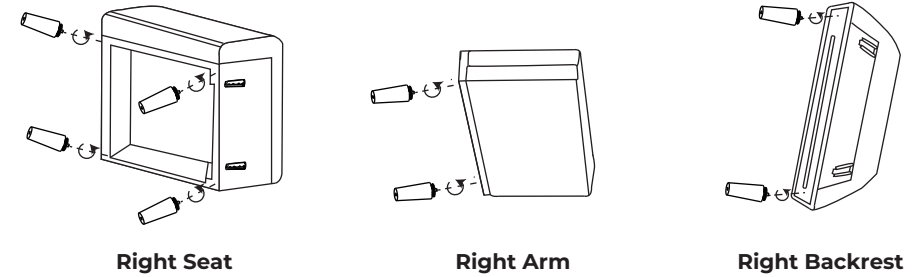

## Step 5

Slide the Right Backrest into Right Seat.

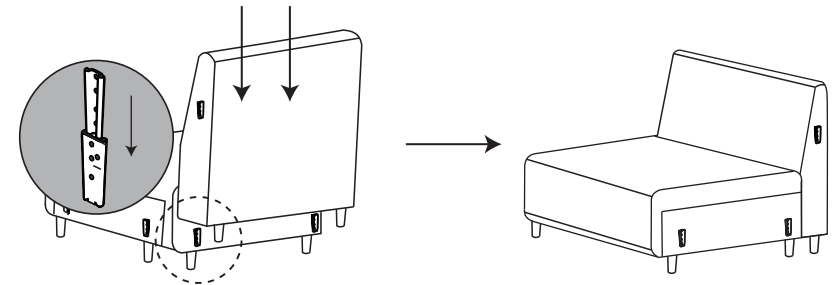

## Step 6

Slide the Right Arm into Right Seat and Backrest.

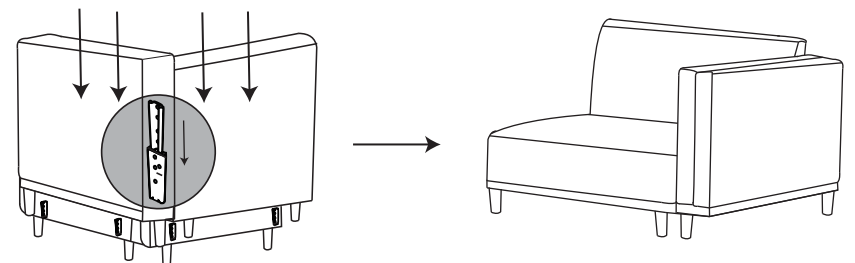

# Right Armchair

## Step 7

Fluff the Seat Cushion and Back Cushion, and put them on the chair to complete the assembly of your Right Armchair.

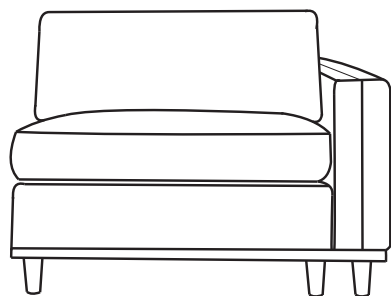

Congratulations!  
Right Armchair is ready!

## Tips

For now, please keep the Metal Connectors aside and you may need them after you have completed the assembly of all modules (See Page 21 to 23 for details).

# Armless Chair

## Parts

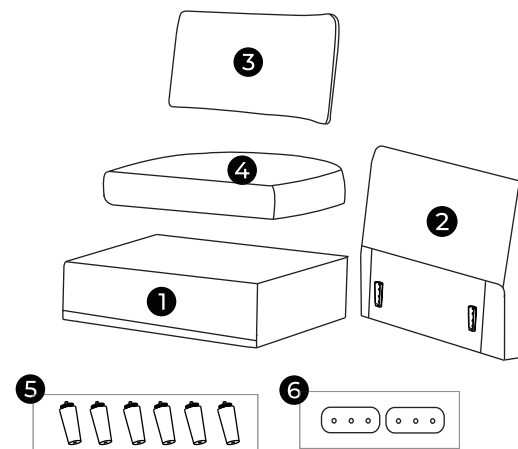

- 1 Armless Seat Base
- 2 Armless Backrest
- 3 Back Cushion
- 4 Seat Cushion
- 5 Leg x 6
- 6 Connector x 2

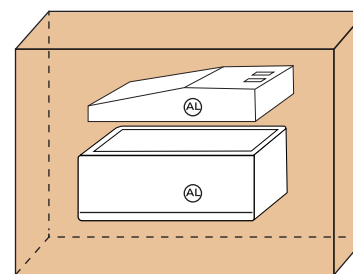

## Armless Chair PIECES INCLUDED

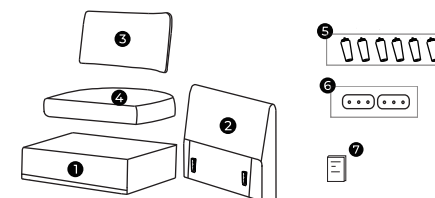

- 1 Armless Seat Base x 1
- 2 Armless Backrest x 1
- 3 Back Cushion x 1
- 4 Seat Cushion x 1
- 5 Leg x 6
- 6 Connector x 2
- 7 Assembly Manual x 1

# Assembly Manual

## Armless Chair

### Step 1

Take out the Seat and Backrest from Armless Box.

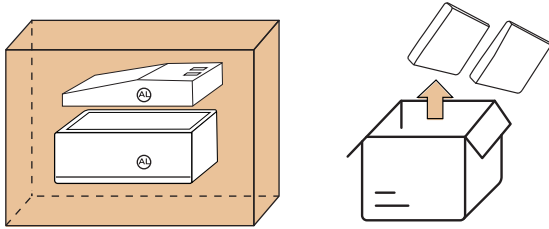

### Step 2

Remove the three wood sticks at the base of the seat to take out the hardware pack, vacuum-packed Seat Cushion and Back Cushion, then open these bags.

⚠ Remove the sticks one by one. Push the stick down and rotate it towards the corner of the base and pull it out. Do NOT use sharp tools such as knives or scissors to open bags as it could potentially damage the cushions. Please use your hands to gently pull the bags apart. Please allow up to 48 hours for the cushions to return to the original thickness.

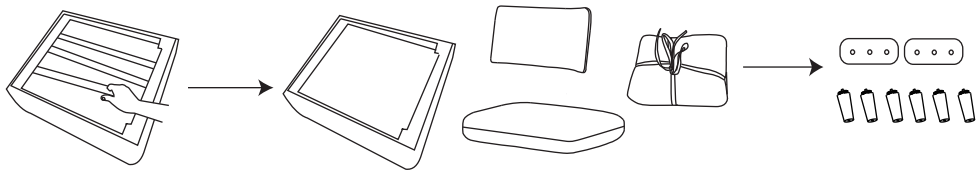

### Step 3

Rotate the Legs firmly.

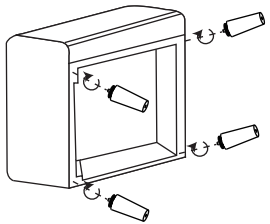

Armless Seat

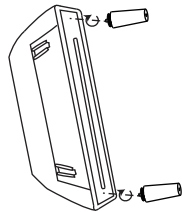

Armless Backrest

# Assembly Manual

## Armless Chair

### Step 4

Slide the Backrest into the Seat.

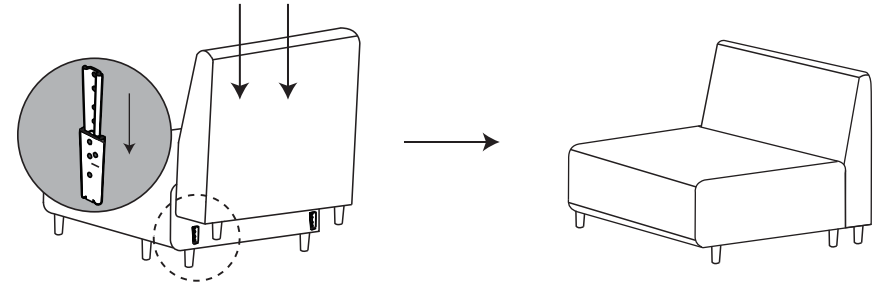

### Step 5

Fluff the Seat Cushion and Back Cushion, and put them on the chair to complete the assembly of your Armless Chair.

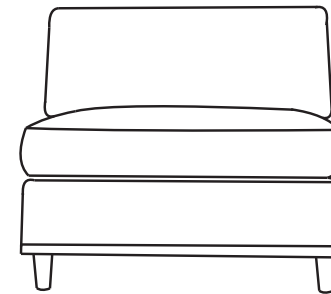

Congratulations!  
Armless Chair is ready!

### Tips

For now, please keep the Metal Connectors aside and you may need them after you have completed the assembly of all modules (See Page 21 to 23 for details).



# Assembly Manual

## Corner

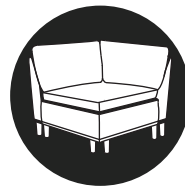

### Parts

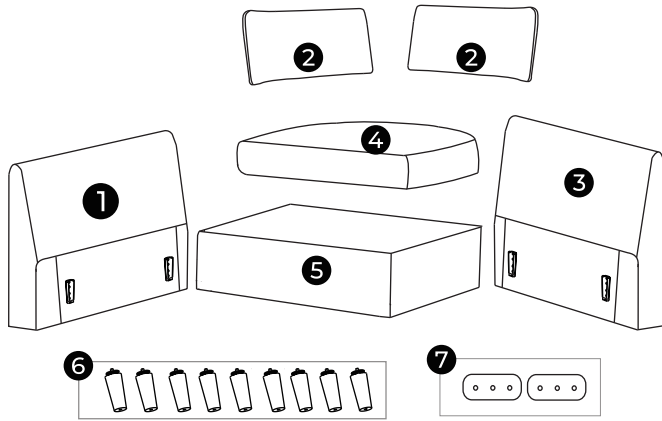

- 1 Corner Left Back C1
- 2 Back Cushion x 2
- 3 Corner Right Back C2
- 4 Seat Cushion
- 5 Corner Seat Base
- 6 Leg x 9
- 7 Connector x 2

# Assembly Manual

## Corner

### Step 1

Take out the Corner Left Back (C1) and Corner Right Back (C2) from Corner Backs Box.

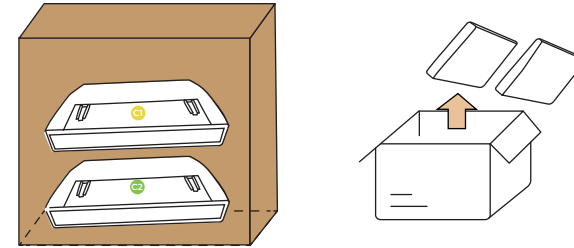

### Step 2

Take out the Seat Base and Back Cushions (2 pieces) from the Corner Seat & Cushions Box.

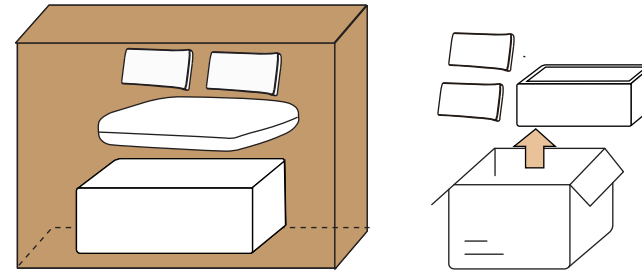

### Step 3

Locate the vacuum-packed Back Cushions on the Corner Seat Base, and open these bags. ⚠ Do NOT use sharp tools such as knives or scissors to open bags as it could potentially damage the cushions. Please use your hands to gently pull the bags apart. Please allow up to 48 hours for the cushions to return to the original thickness.

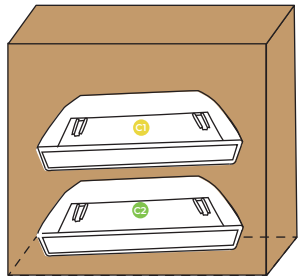
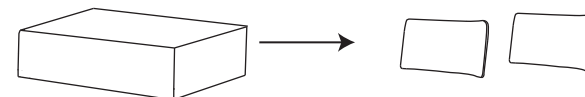

### Corner Backs PIECES INCLUDED

- 1 Corner Left Back C1 x1
- 2 Corner Right Back C2 x1

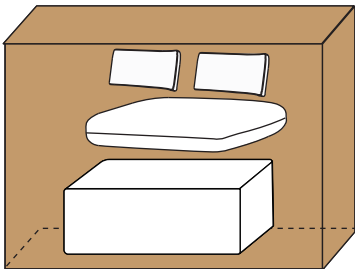
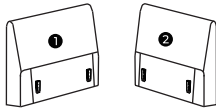

### Corner Seat & Cushions PIECES INCLUDED

- 1 Corner Seat Base x1
- 2 Back Cushion x2
- 3 Seat Cushion x1
- 4 Leg x9
- 5 Connector x2
- 6 Assembly Manual x1

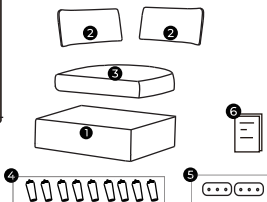

# Corner

## Step 4

Remove the three wood sticks at the base of the seat to take out the hardware pack and vacuum-packed Seat Cushion, then open these bags.

⚠ Remove the sticks one by one. Push the stick down and rotate it towards the corner of the base and pull it out. Do NOT use sharp tools such as knives or scissors to open bags as it could potentially damage the cushions. Please use your hands to gently pull the bags apart. Please allow up to 48 hours for the cushions to return to the original thickness.

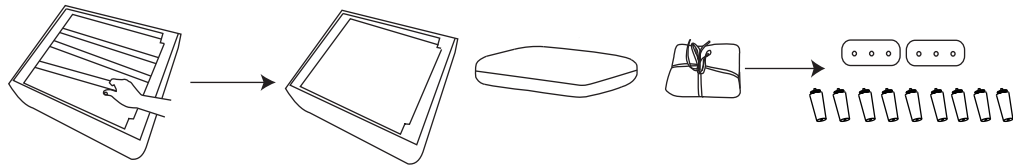

## Step 5

Rotate the Legs firmly.

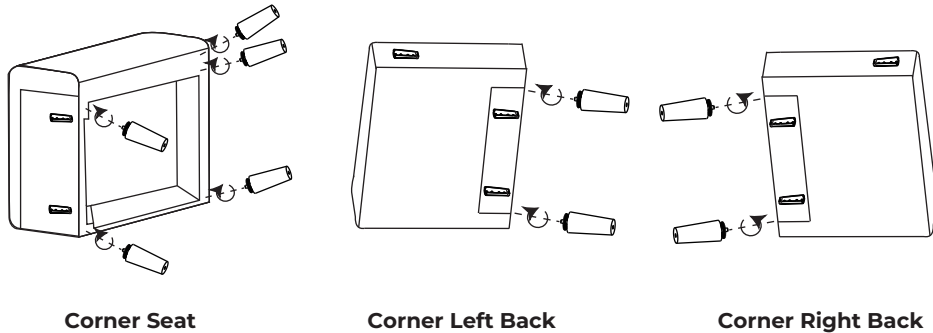

Corner Seat

Corner Left Back

Corner Right Back

## Step 6

Slide the Corner Left Back (C1) into the side of Seat Base marked with C1.

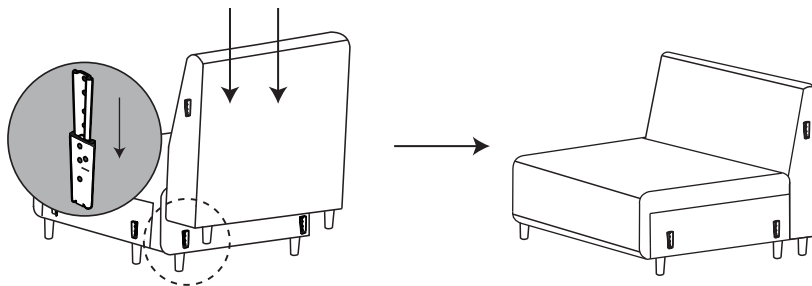

# Corner

## Step 7

Slide the Corner Right Back (C2) into the side of Seat Base marked with C2.

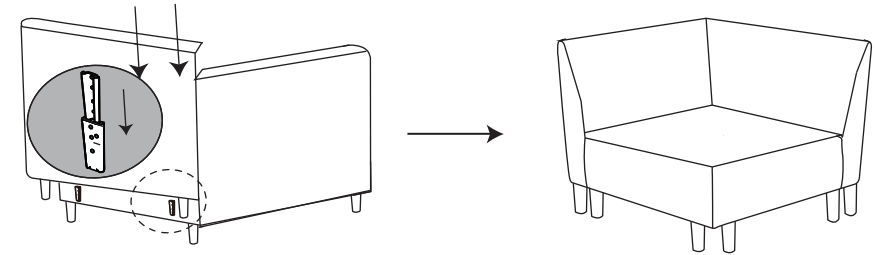

## Step 8

Fluff the Seat Cushion and Back Cushions, and put them on the chair to complete the assembly of your Corner.

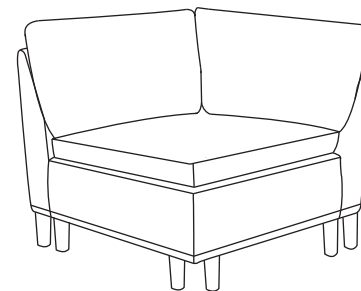

Congratulations!  
Corner is ready!

## Tips

For now, please keep the Metal Connectors aside and you may need them after you have completed the assembly of all modules (See Page 21 to 23 for details).

# Assembly Manual Ottoman



## Parts

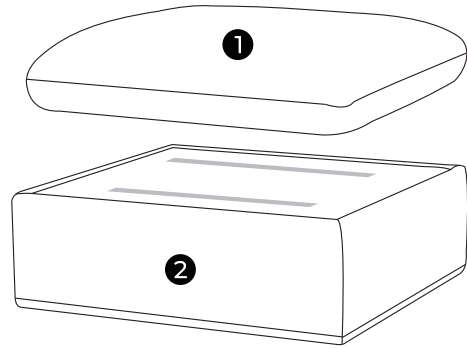

- ① Seat Cushion
- ② Seat Base
- ③ Leg x 4

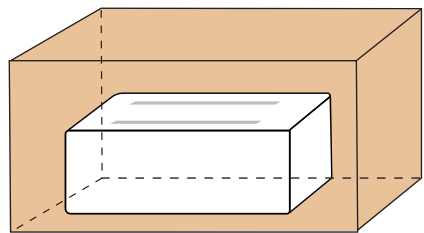
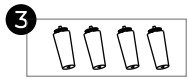

**Ottoman  
PIECES INCLUDED**

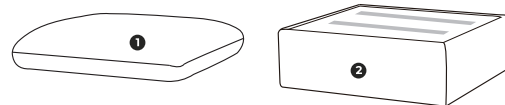

- ① Seat Cushion x 1
- ② Seat Base x 1
- ③ Leg x 4
- ④ Assembly Manual x 1

# Assembly Manual Ottoman

## Step 1

Take out the Seat Base from Ottoman Box.

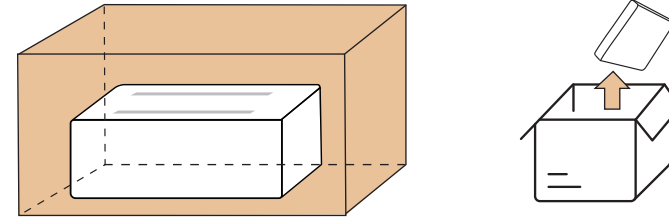

## Step 2

Remove the three wood sticks at the base of the seat to take out the hardware pack and vacuum-packed Seat Cushion, then open these bags.

⚠ Remove the sticks one by one. Push the stick down and rotate it towards the corner of the base and pull it out. Do NOT use sharp tools such as knives or scissors to open bags as it could potentially damage the cushion. Please use your hands to gently pull the bags apart. Please allow up to 48 hours for the cushion to return to the original thickness.

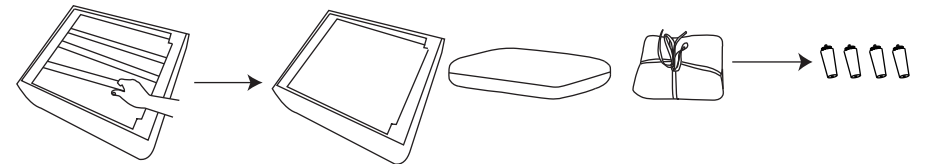

## Step 3

Rotate the Legs firmly.

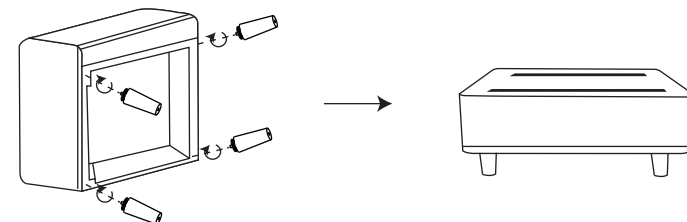

# Ottoman

## Step 4

Remove the velcro protectors on the top of the Seat.

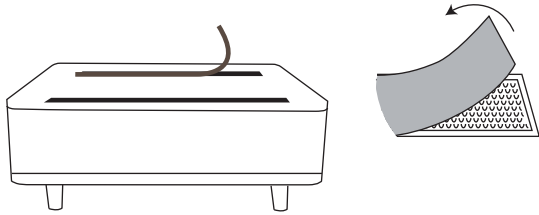

## Step 5

Fluff the Seat Cushion. Attach it to the Seat Base to complete the assembly of your Ottoman.

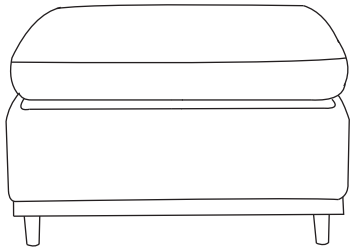

**Congratulations!**  
Ottoman is ready!

# Bonus Feature

Now you have successfully completed the assembly of each module. Based on the number of modules you purchased, you may remix your Liam in multiple configurations. In the diagrams on following pages, there are several configurations for your reference. After you decide which configuration you love the most, you may connect the chairs with Metal Connectors. In addition to non-slip legs, these Metal Connectors are provided to further help prevent the chairs from sliding apart.

**Step 1:** Put the chairs side by side, with the base of the chair facing you.



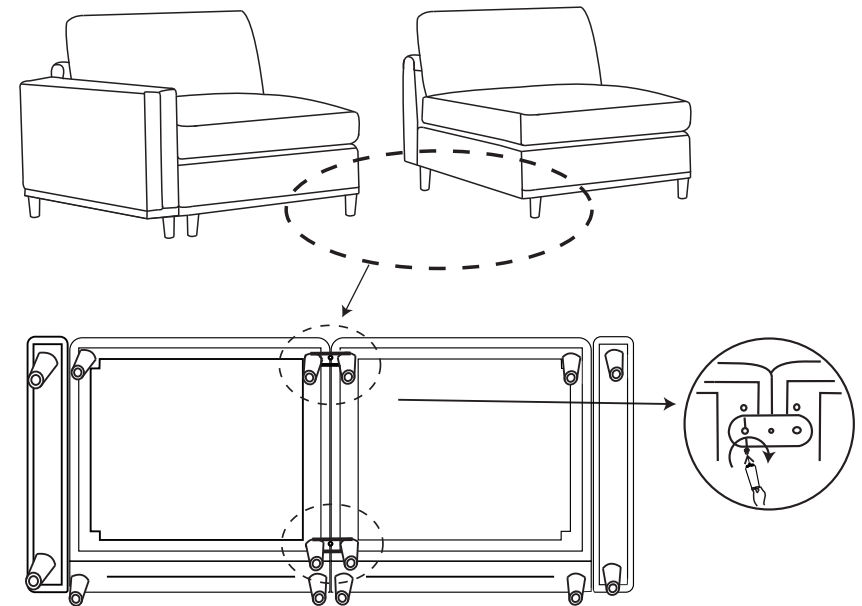

**Step 2:** Attach the Metal Connectors by screwing on the legs firmly. You may have a few extra Metal Connectors left over. They are included in case you want to connect additional modules in the future. We recommend storing them in the little zip-top bag in case you decide to expand your Liam later.

**Note:** Ottoman is a standalone piece and cannot be attached to any chair with Metal Connectors.

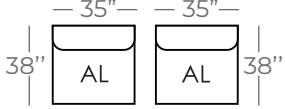

# Modular Sofa

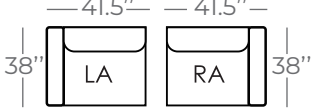
## Multiple Congurations

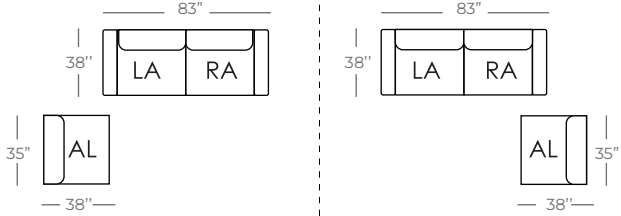
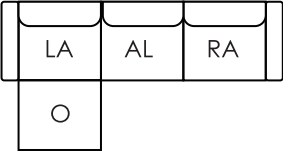
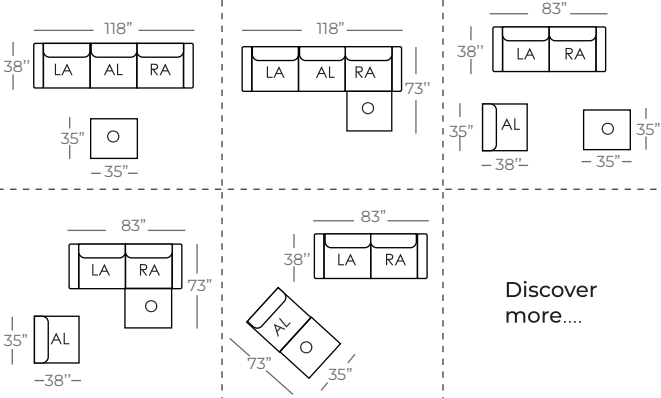
<p><b>2-piece Armless</b></p>  <p>W 70" x D 38" x H 33"</p>	
<p><b>2-piece Sofa</b></p>  <p>W 83" x D 38" x H 33"</p>	
<p><b>3-piece Sofa</b></p>  <p>W 118" x D 38" x H 33"</p>	
<p><b>4-piece Sofa-Chaise</b></p>  <p>W 118" x D 73" x H 33"</p>	 <p>Discover more....</p>

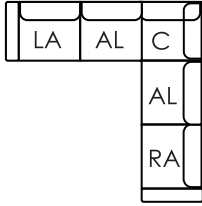
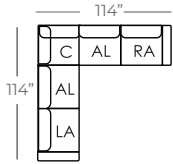
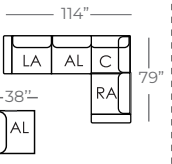
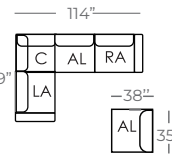
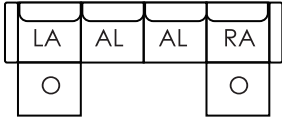
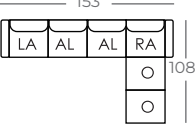
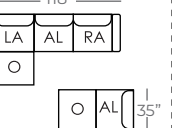
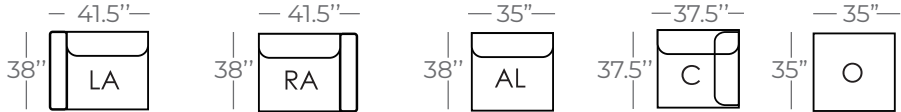
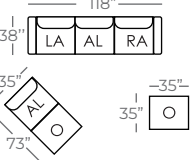
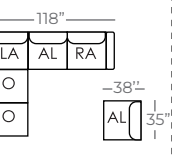
<p><b>5-piece Modular Sectional</b></p>  <p>W 114" x D 114" x H 33"</p>			
<p><b>6-piece Modular Sectional</b></p>  <p>W 153" x D 73" x H 33"</p>			<p>Discover more....</p>
<p>Left Armchair    Right Armchair    Armless Chair    Corner    Ottoman</p> 			<p>Discover more....</p>

## Care Instruction

### For non-removable areas:

Blot and spot clean immediately with a clean, absorbent cloth and a water-free stain remover (Cleaning Code: S).

### For cushion covers:

- Ⓟ Dry clean only.
- ☒ Do not tumble dry.
- ☒ Do not bleach.
- ☒ Iron at low temperature (230°F / 110°C or below).

