

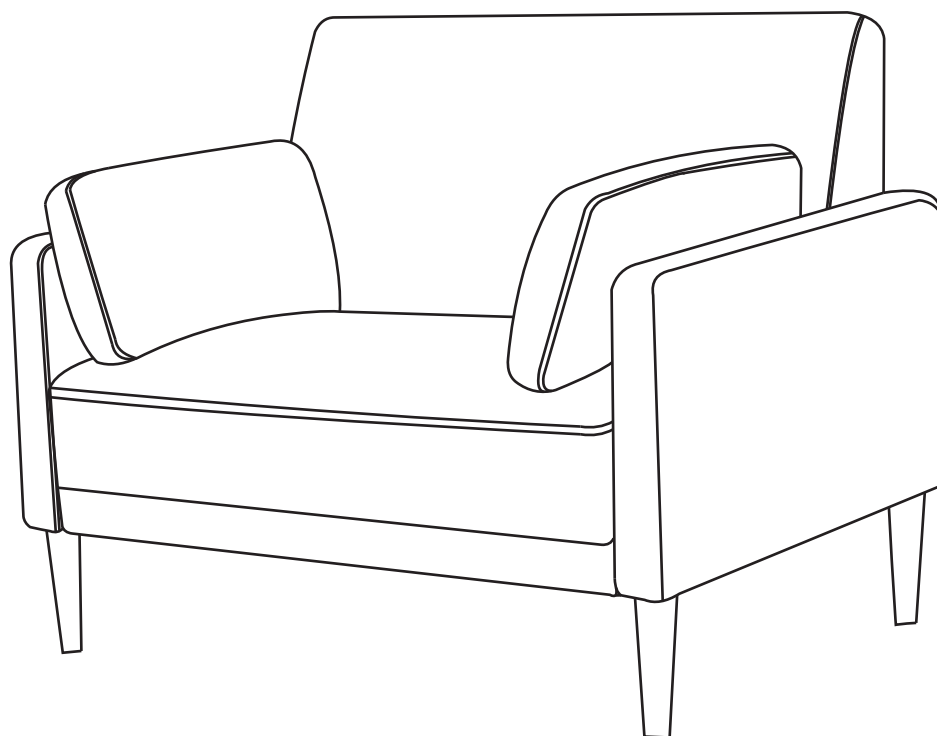

S-72713-1S Assembly Manual Chair



CAUTION

THIS ASSEMBLY MANUAL CONTAINS IMPORTANT SAFETY INFORMATION.

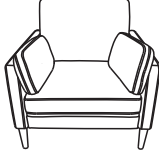
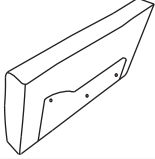
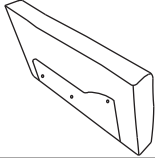
PLEASE READ AND KEEP FOR FUTURE REFERENCE.

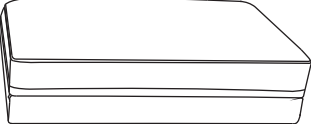
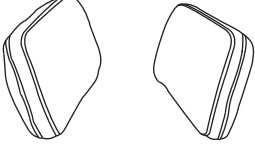
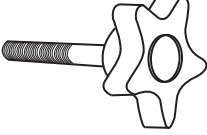
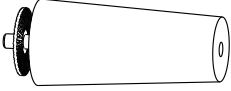
PART	DRAWING		QTY
A1		Right Facing Arm	1
B1		Left Facing Arm	1
A2		Back Cushion	1
A3		Seat Cushion	1
Z1		Arm Pillow	2
H1		Thumb Screw	8
H2		Wood Leg with washer	4

ASSEMBLY INSTRUCTIONS

STEP 1

Please lay all parts on soft, clean surface to assemble.

Unzip and remove the arm from the base of the seat cushion, and the legs with washers, thumb screws and arm pillow from the bottom of the back cushion.

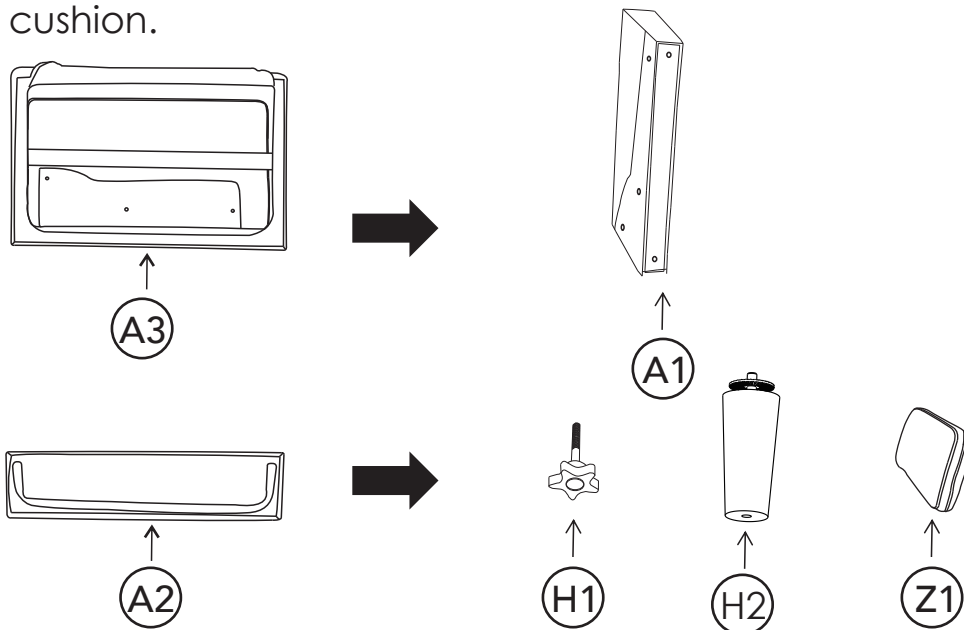

STEP 2

Lay the back cushion down and attach seat cushion with thumb screws. Secure & tighten firmly.

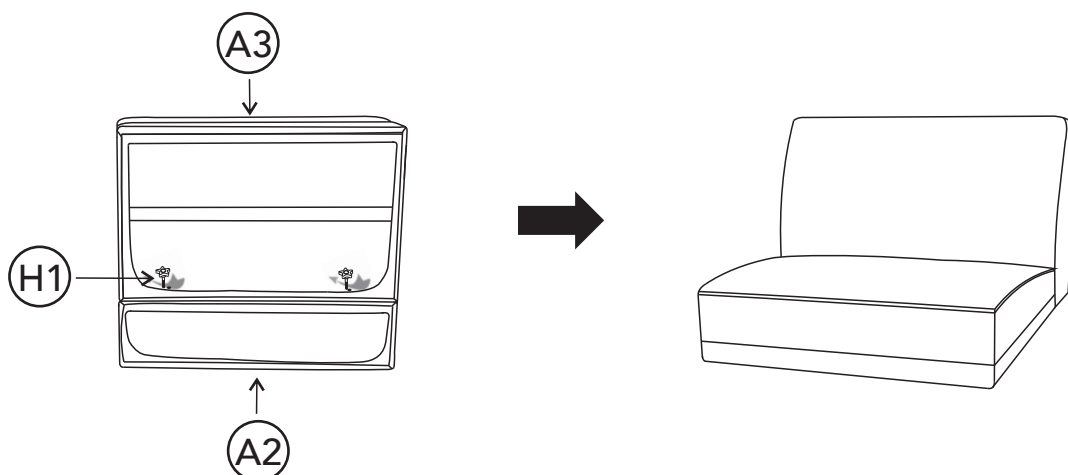

STEP 3

Attach arms with thumb screws. Secure & tighten firmly.

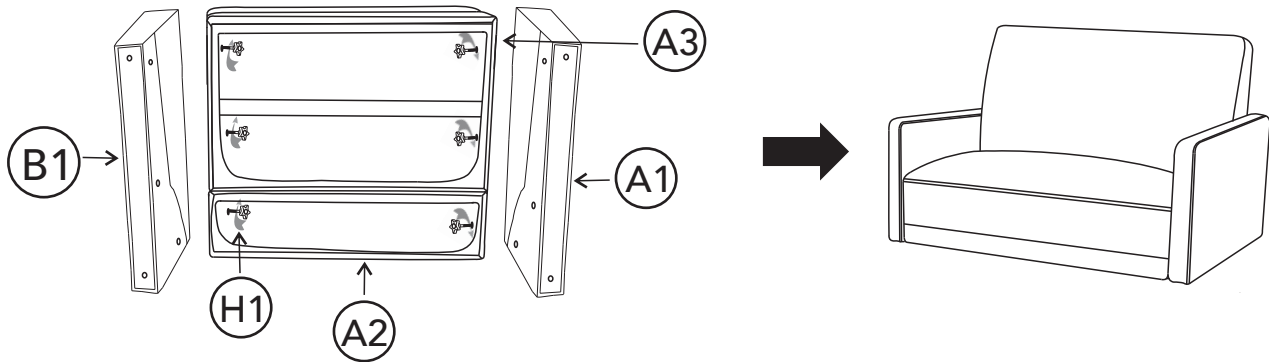

STEP 4

Attach the legs to the bottom of the chair with the included thumb screws. Secure & tighten firmly.

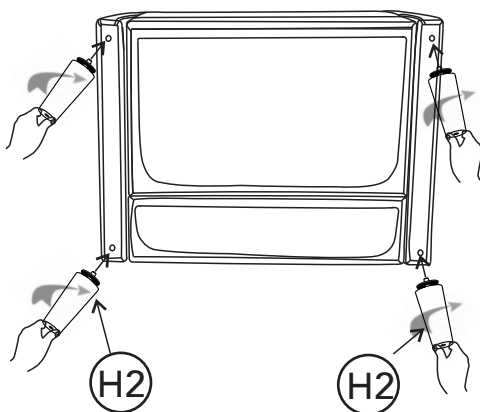

STEP 5

Carefully place the chair on its legs. Inspect and be sure all legs are in contact with the floor. Place the arm pillows on the chair.

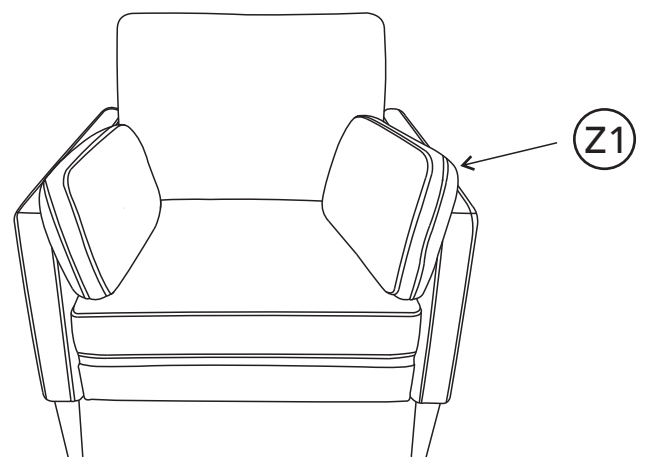

Congratulations. We hope you enjoy your new piece of furniture.