

## S-72715-3S

# Assembly Manual

## Sofa

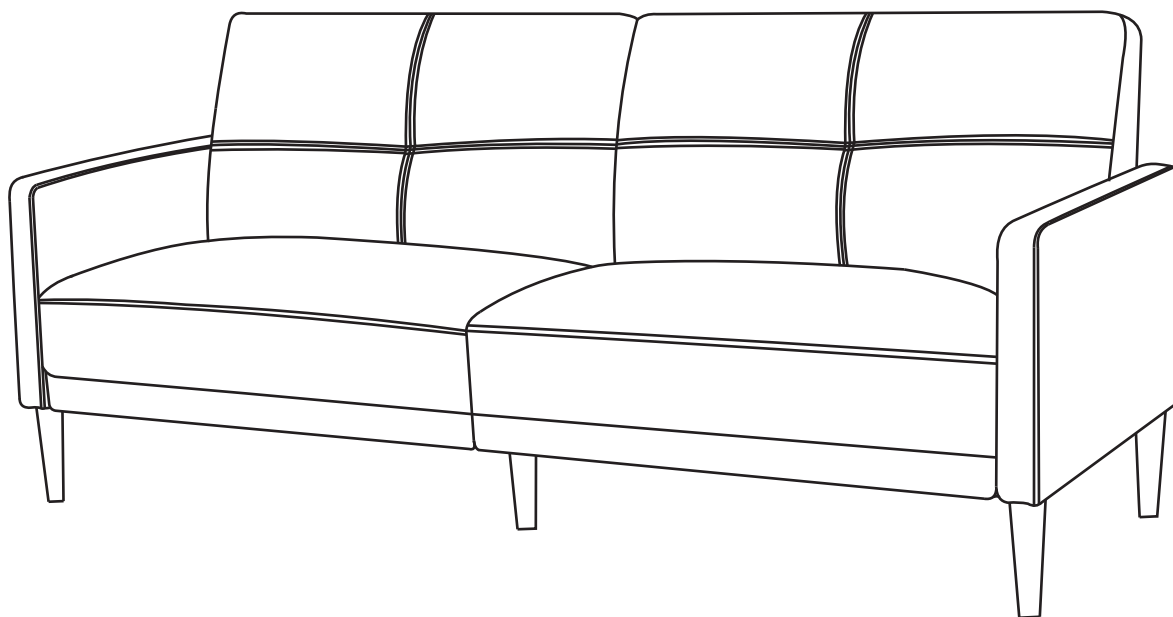

### CAUTION

THIS ASSEMBLY MANUAL CONTAINS IMPORTANT SAFETY INFORMATION.

PLEASE READ AND KEEP FOR FUTURE REFERENCE.

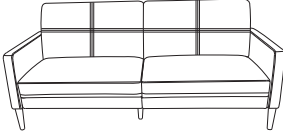
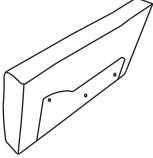
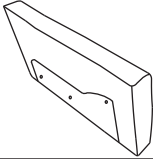
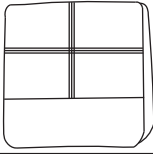
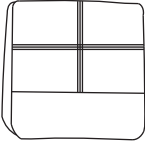
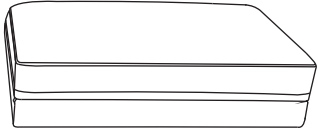
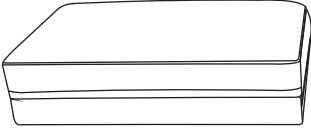
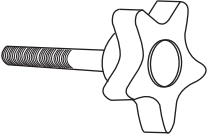
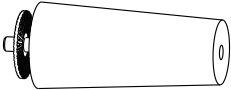
PART	DRAWING		QTY
A1		Right Facing Arm	1
B1		Left Facing Arm	1
A2		Right Back Cushion	1
B2		Left Back Cushion	1
A3		Right Seat Cushion	1
B3		Left Seat Cushion	1
H1		Thumb Screw	13
H2		Wood Leg with washer	6

## ASSEMBLY INSTRUCTIONS

### STEP 1

Please lay all parts on soft, clean surface to assemble.

Unzip and remove the arm from the base of the seat cushion, and the legs with washer, thumb screws and arm pillows from the bottom of the back cushion.

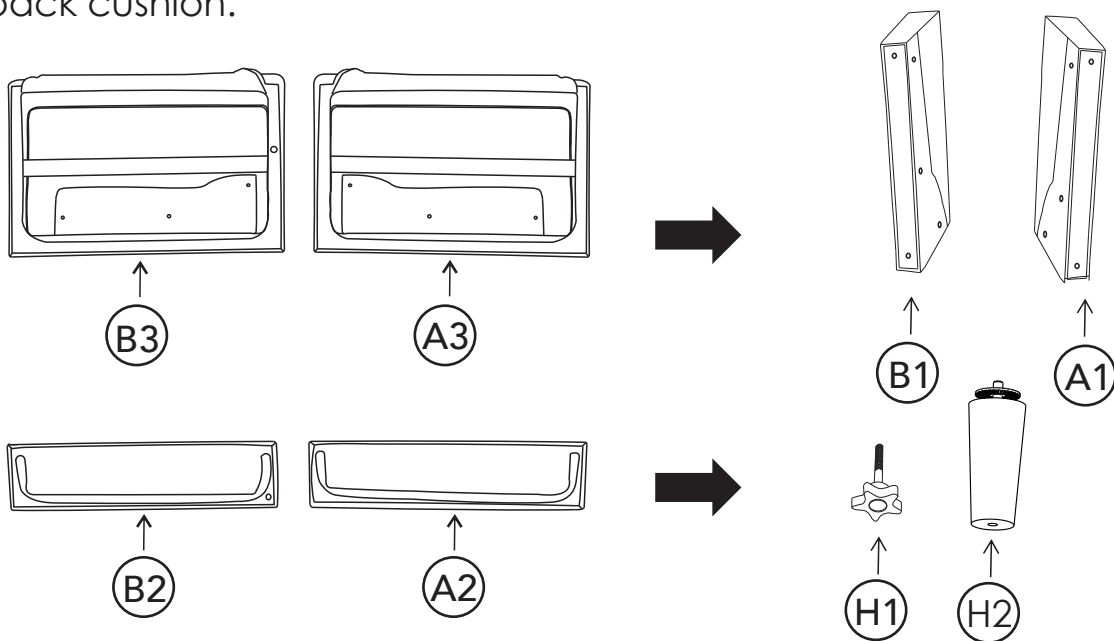

### STEP 2

Lay the back cushion down and attach seat cushion with thumb screws. Secure & tighten firmly.

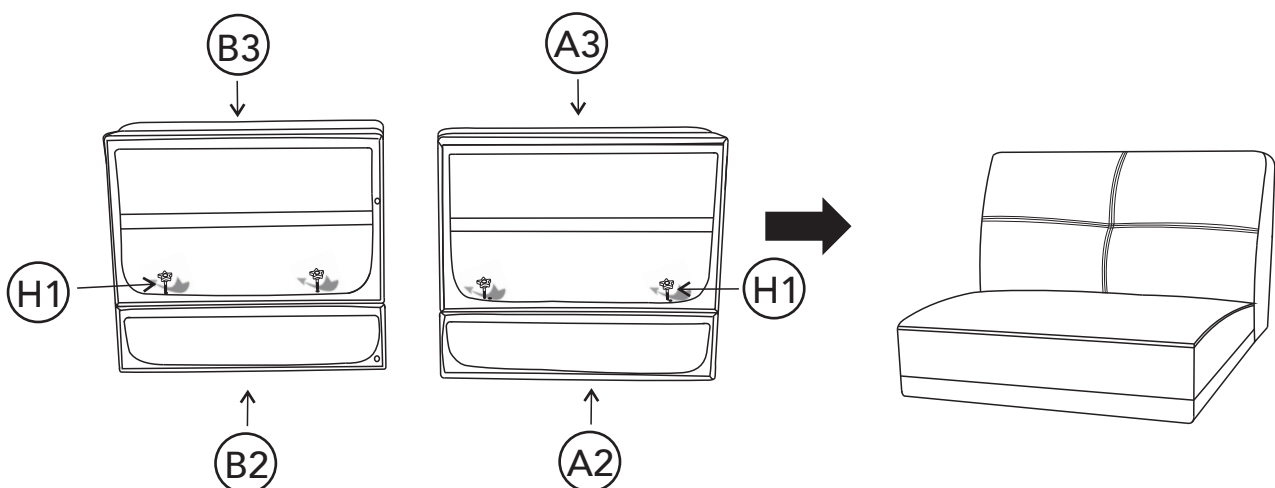

## STEP 3

Attach each seat together with thumb screws. Secure & tighten firmly.

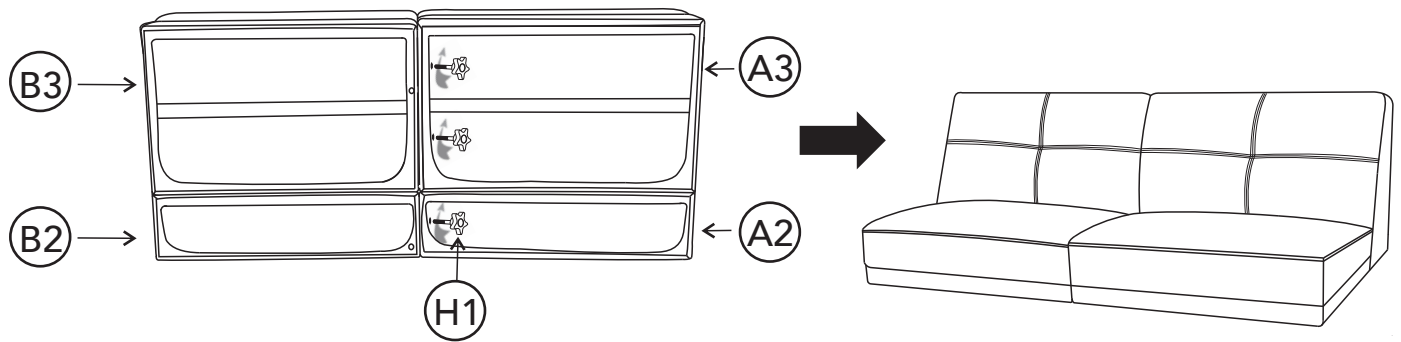

## STEP 4

Attach arms with thumb screws. Secure & tighten firmly.

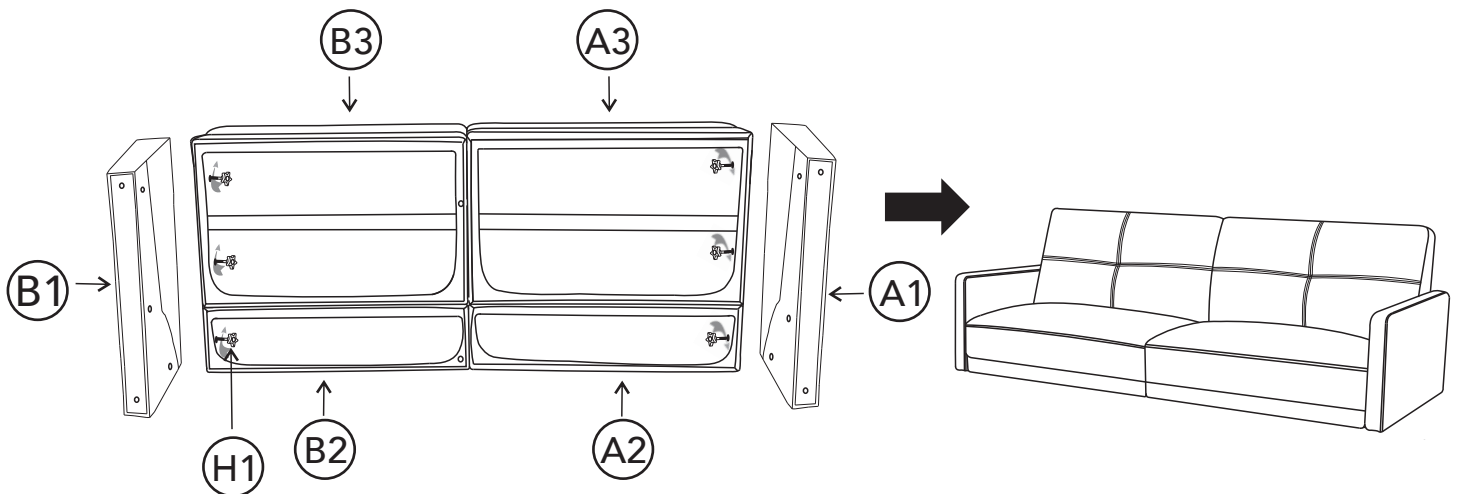

## STEP 5

Attach the legs to the bottom of the sofa with the included thumb screws. Secure & tighten firmly.

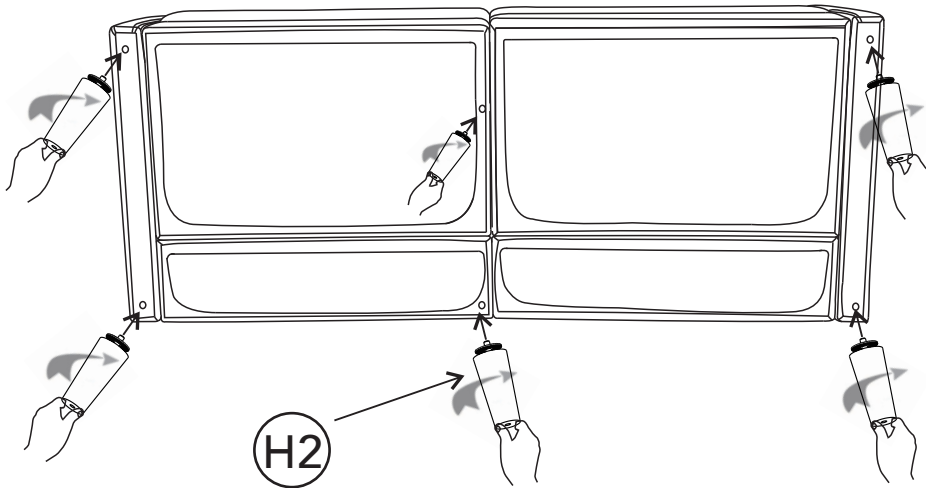

## STEP 6

Carefully place the sofa on its legs. Inspect and be sure all legs are in contact with the floor.

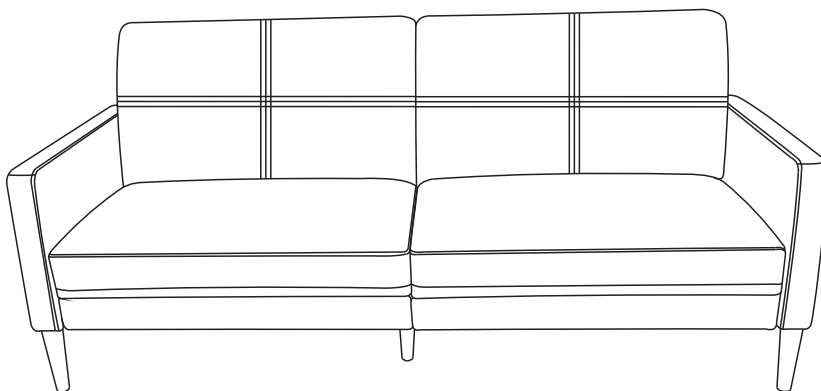

Congratulations. We hope you enjoy your new piece of furniture.