

CHITA®

CHITA®

Assembly Manual

Sophia Collection

Modular Sofa

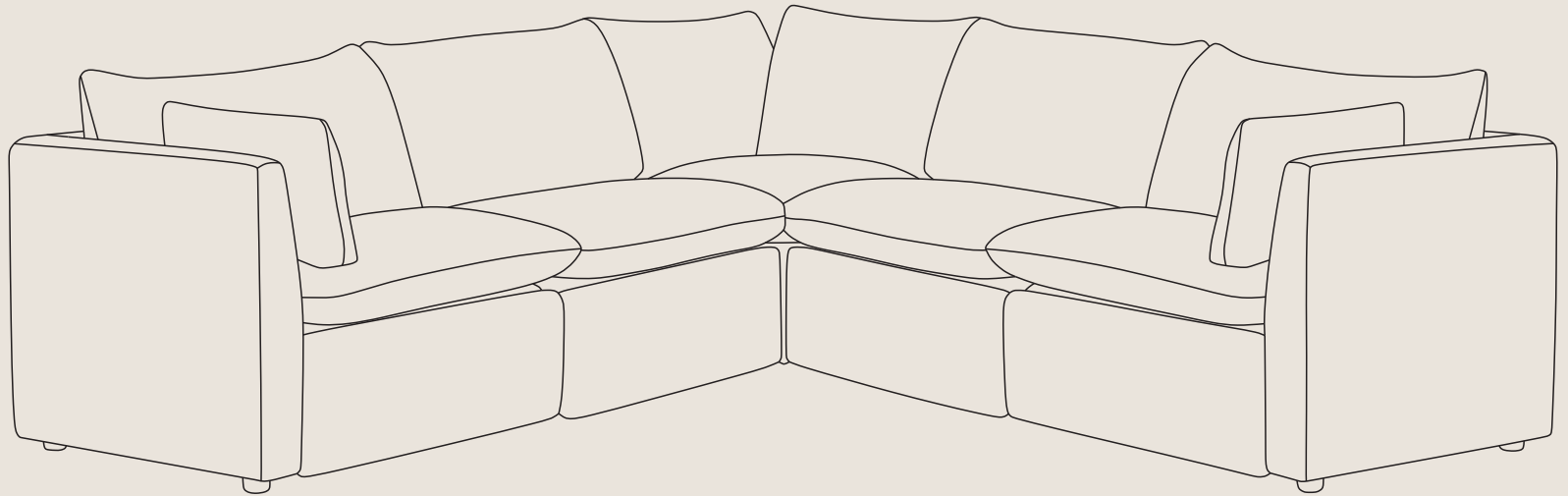

Follow Us

 @chitalivingofficial

 @chitaliving

 @chitaliving

 @chitaliving

If at any step you need a helping hand, we're always here for you. You can email us, or hop into a live chat on our website — whatever method is convenient for you.

 support@chitaliving.com

Thank you for purchasing from CHITA LIVING. Please read this manual carefully before using and keep this manual for future reference.

The design and /or specification of this product is subject to change without notice.

Welcome to CHITA LIVING

If you are reading these instructions, the hard part is already out of the way. Surrounded by all these boxes, you may feel a little overwhelmed. No worries, we will walk you through and you will find the assembly process easy, intuitive and mostly, fun. Here are some tips before you get started.













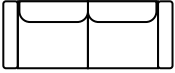







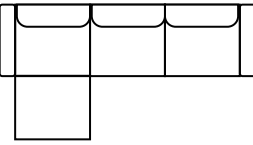





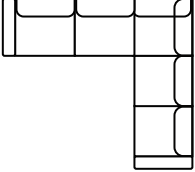

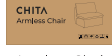

1. Count the boxes. Check if you have received all boxes using the diagram on next page. Do not start the assembly process until all boxes are present. If you have not received all boxes or received wrong boxes, please contact our customer service at support@chitaliving.com and we will get back to you. Do not discard any of the packaging until you are certain that you have all the necessary parts for the assembly.

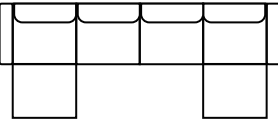
2. Do not open all boxes at once. Start with Arms Box and (Power) Left Chair Seat & Backrest Box to assemble the (Power) Left Armchair. Then, move on to open the (Power) Right Chair Seat & Backrest Box to assemble the (Power) Right Armchair. Next, assemble the (Power) Armless Chair, Corner, and finally, the Ottoman.











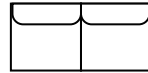



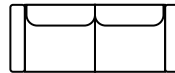











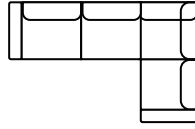







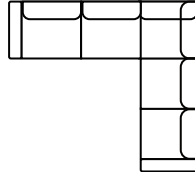







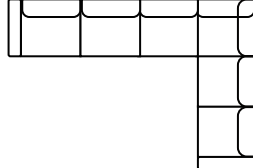

3. After the assembly is complete, feel free to enjoy your Sophia Collection as much as you can. However, please ensure that the packaging is disposed of in a safe and environmentally responsible way.

4. For your safety (as well as Sophia's), do not sit on the backrest during and after assembly and never use this sofa as a step ladder.

Stationary Modular Collection.

| | |
|--|--|
| <p>2-piece Armless</p>  | <p>Box × 2</p>   <p>Armless Chair Armless Chair</p> |
| <p>2-piece Sofa</p>  | <p>Box × 3</p>    <p>Arms Left Chair Seat & Backrest Right Chair Seat & Backrest</p> |
| <p>3-piece Sofa</p>  | <p>Box × 4</p>     <p>Arms Left Chair Seat & Backrest Right Chair Seat & Backrest Armless Chair</p> |
| <p>4-piece Modular</p>  | <p>Box × 5</p>      <p>Arms Left Chair Seat & Backrest Right Chair Seat & Backrest Armless Chair</p> <p>Ottoman</p> |
| <p>5-piece Corner Modular</p>  | <p>Box × 7</p>        <p>Arms Left Chair Seat & Backrest Right Chair Seat & Backrest Armless Chair</p> <p>Armless Chair Corner Backs Corner Seat & Cushions</p> |
| <p>6-piece Modular</p>  | <p>Box × 7</p>        <p>Arms Left Chair Seat & Backrest Right Chair Seat & Backrest Armless Chair</p> <p>Armless Chair Ottoman Ottoman</p> |

Motion Modular Collection

| | |
|---|--|
| <p>2-piece Power Armless</p>  | <p>Box × 4</p>     <p>Armless Recliner Back Armless Recliner Seat Power Armless Chair Back Power Armless Chair Seat</p> |
| <p>2-piece Sofa with 2 Power Recliners</p>  | <p>Box × 5</p>      <p>Arms Power Left Chair Seat Power Left Chair Back Power Right Chair Seat Power Right Chair Back</p> |
| <p>3-piece Sofa with 2 Power Recliners</p>  | <p>Box × 6</p>       <p>Arms Power Left Chair Seat Power Left Chair Back Power Right Chair Seat Power Right Chair Back</p> <p>Armless Chair</p> |
| <p>4-piece Modular with 2 Power Recliners</p>  | <p>Box × 8</p>         <p>Arms Power Left Chair Seat Power Left Chair Back Power Right Chair Seat Power Right Chair Back</p> <p>Armless Chair Corner Backs Corner Seat & Cushions</p> |
| <p>5-piece Modular with 2 Power Recliners</p>  | <p>Box × 9</p>          <p>Arms Power Left Chair Seat Power Left Chair Back Power Right Chair Seat Power Right Chair Back</p> <p>Armless Chair Armless Chair Corner Backs Corner Seat & Cushions</p> |
| <p>6-piece Corner Modular with 2 Power Recliners</p>  | <p>Box × 10</p>           <p>Arms Power Left Chair Seat Power Left Chair Back Power Right Chair Seat Power Right Chair Back</p> <p>Armless Chair Armless Chair Armless Chair Corner Backs Corner Seat & Cushions</p> |

Assembly Manual

Left Armchair



Parts

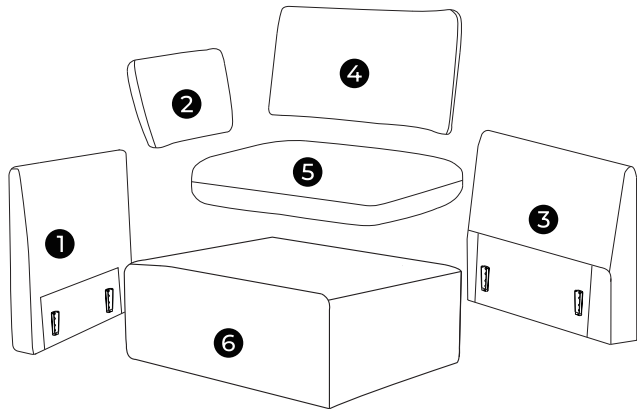

- ① Left Arm
- ② Arm Pillow
- ③ Left Backrest
- ④ Back Cushion
- ⑤ Seat Cushion
- ⑥ Left Seat Base
- ⑦ Leg x 8

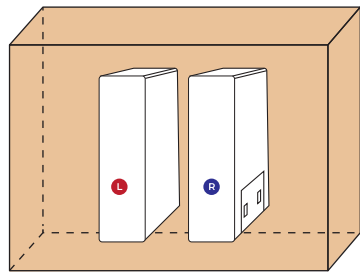

Note: Left & Right Arms are packed together in Arms Box.

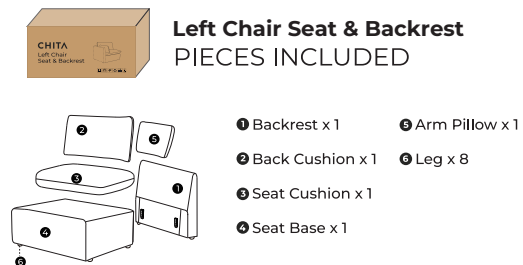
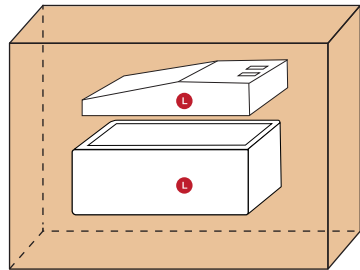
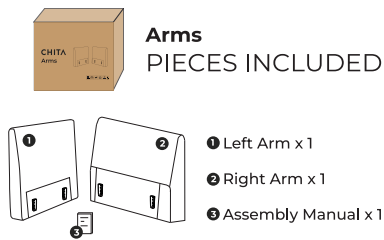

Assembly Manual

Left Armchair

Step 1

Take out the Left Arm (L) from Arms Box.

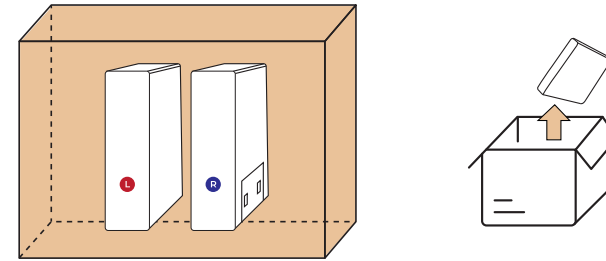

Step 2

Take out the Left Seat and Backrest from Left Chair Seat & Backrest Box.

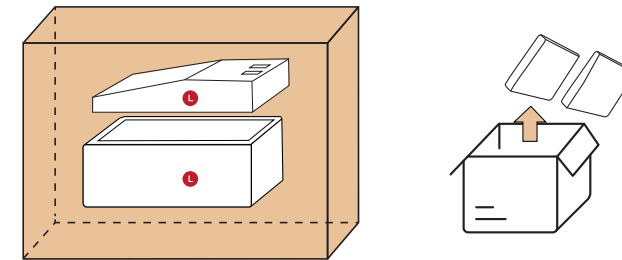

Step 3

Remove the three wood sticks at the base of the seat to take out the Seat Cushion, Back Cushion, and Arm Pillow. ⚠ Remove the sticks one by one. Push the stick down and rotate it towards the corner of the base and pull it out. Once all sticks are out, take out the cushions carefully.

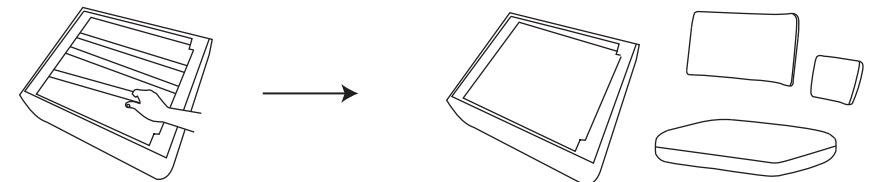

Assembly Manual

Left Armchair

Step 4

Take out the Legs (8 pieces) from the bottom of the Backrest.

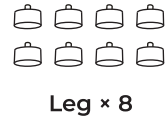
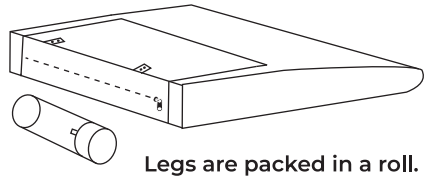

Step 5

Rotate the Legs firmly.

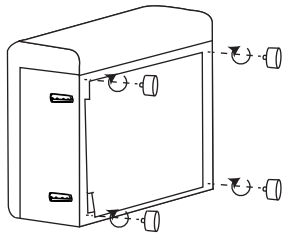

Left Seat

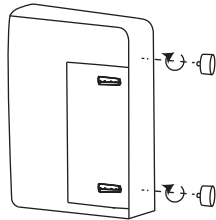

Left Arm

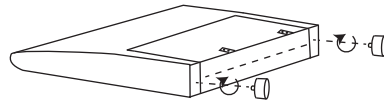

Left Backrest

Step 6

Slide the Left Backrest into the Left Seat.

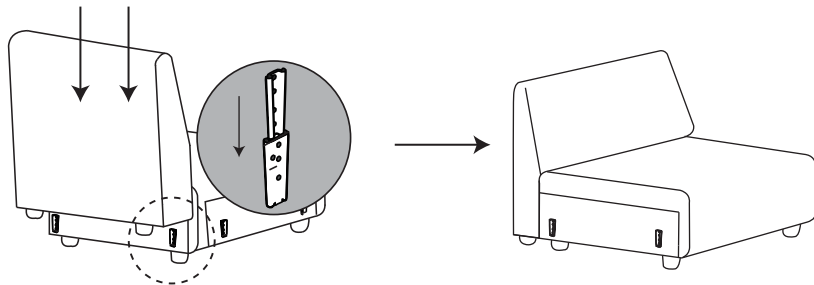

Assembly Manual

Left Armchair

Step 7

Slide the Left Arm into the Left Seat and Backrest.

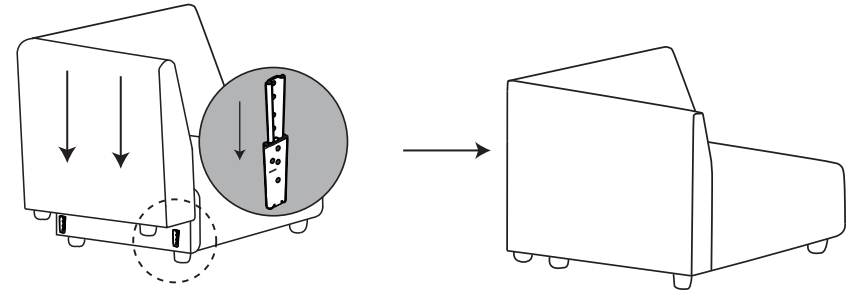

Step 8

Fluff the Seat Cushion, Back Cushion, and Arm Pillow, and put them on the chair to complete the assembly of your Left Armchair.

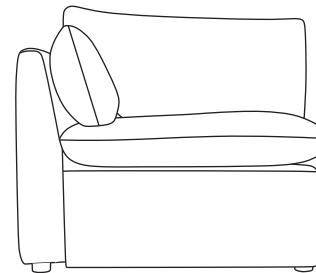

Congratulations!
Left Armchair is ready!

Assembly Manual

Right Armchair



Parts

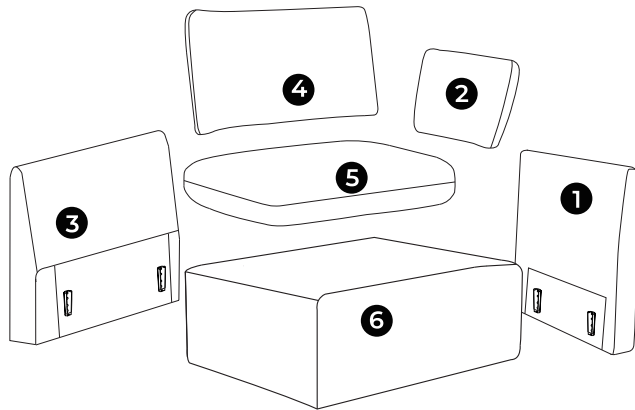

- 1 Right Arm
- 2 Arm Pillow
- 3 Right Backrest
- 4 Back Cushion
- 5 Seat Cushion
- 6 Right Seat Base
- 7 Leg x 8

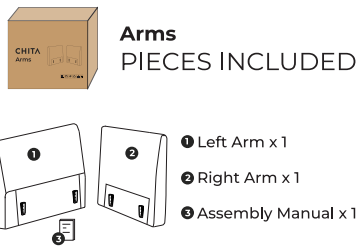
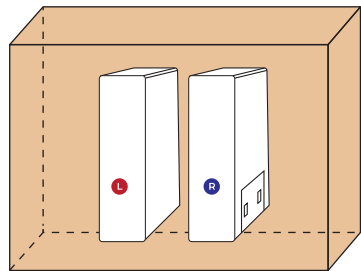

Note: Left & Right Arms are packed together in Arms Box.

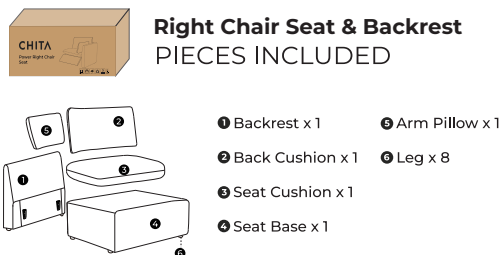
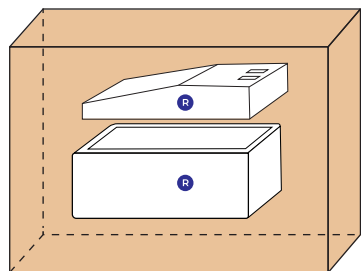

Assembly Manual

Right Armchair

Step 1

Take out the Right Arm (R) from Arms Box.

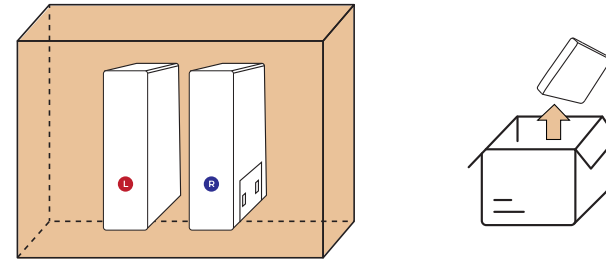

Step 2

Take out the Right Seat and Backrest from Right Chair Seat & Backrest Box.

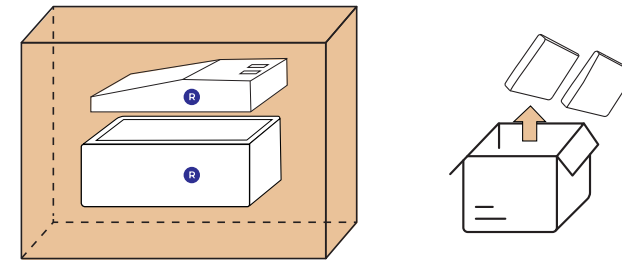

Step 3

Remove the three wood sticks at the base of the seat to take out the Seat Cushion, Back Cushion, and Arm Pillow. ⚠ Remove the sticks one by one. Push the stick down and rotate it towards the corner of the base and pull it out. Once all sticks are out, take out the cushions carefully.

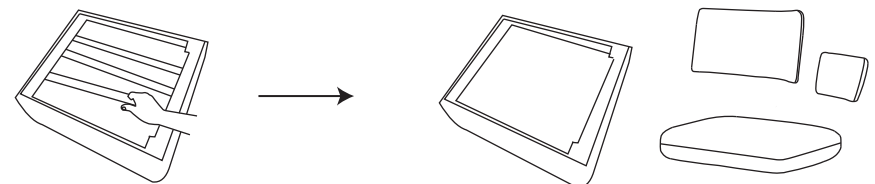

Right Armchair

Step 4

Take out the Legs (8 pieces) from the bottom of the Backrest.

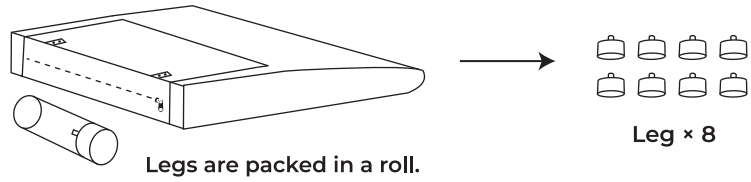

Step 5

Rotate the Legs firmly.

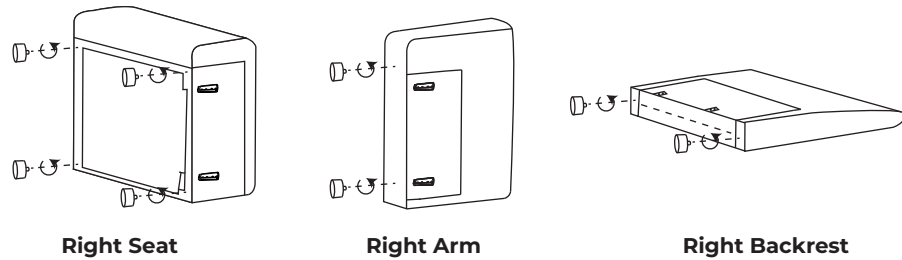

Step 6

Slide the Right Backrest into the Right Seat.

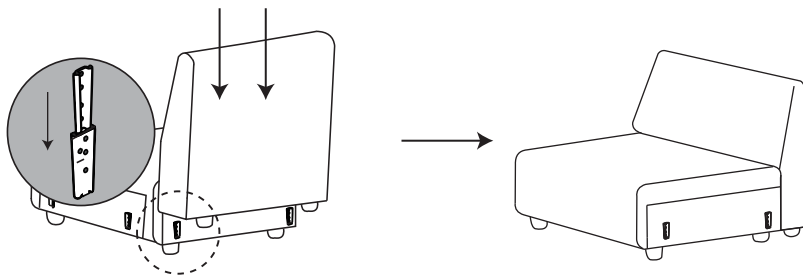

Right Armchair

Step 7

Slide the Right Arm into the Right Seat and Backrest.

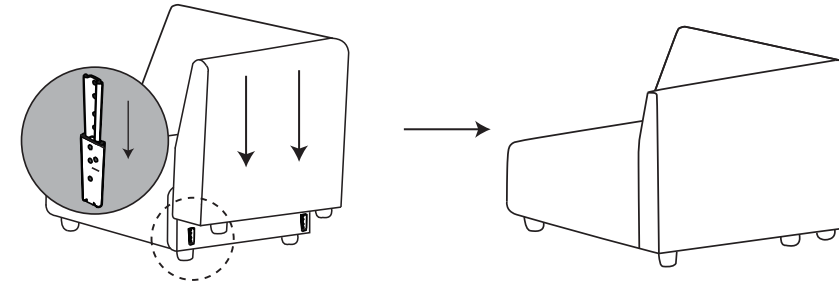

Step 8

Fluff the Seat Cushion, Back Cushion, and Arm Pillow, and put them on the chair to complete the assembly of your Right Armchair.

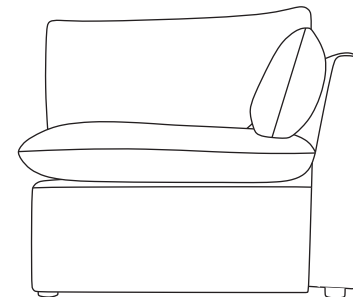

Congratulations!
Right Armchair is ready!

Assembly Manual

Armless Chair



Parts

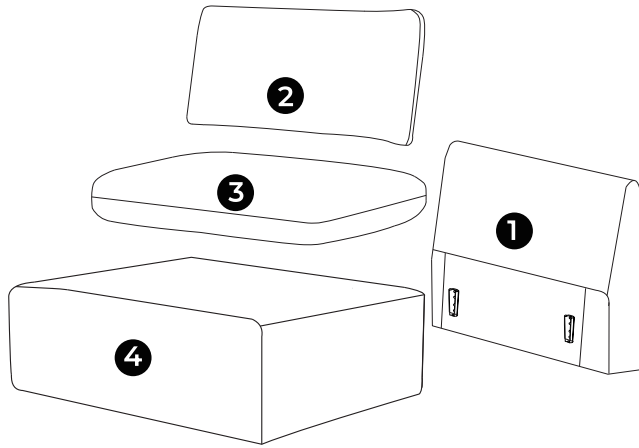

- ① Backrest
- ② Back Cushion
- ③ Seat Cushion
- ④ Seat Base
- ⑤ Leg × 6

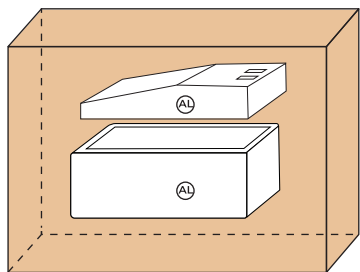

Armless Chair PIECES INCLUDED

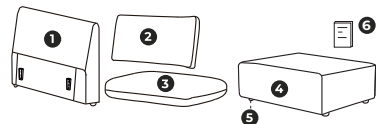

- ① Backrest x 1
- ② Back Cushion x 1
- ③ Seat Cushion x 1
- ④ Seat Base x 1
- ⑤ Leg x 6
- ⑥ Assembly Manual x 1

Assembly Manual

Armless Chair

Step 1

Take out the Seat and Backrest from Armless Box.

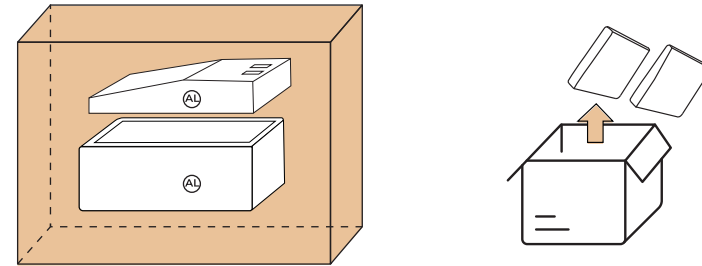

Step 2

Remove the three wood sticks at the base of the seat to take out the Seat Cushion and Back Cushion.

⚠ Remove the sticks one by one. Push the stick down and rotate it towards the corner of the base and pull it out. Once all sticks are out, take out the cushions carefully.

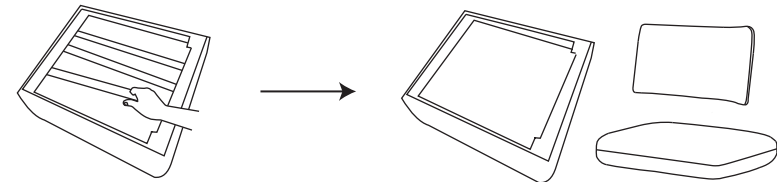

Step 3

Take out the Legs (6 pieces) from the bottom of the Backrest.

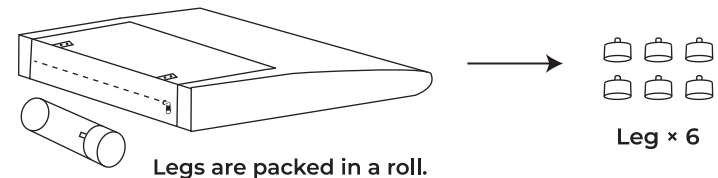

Assembly Manual

Armless Chair

Step 4

Rotate the Legs firmly.

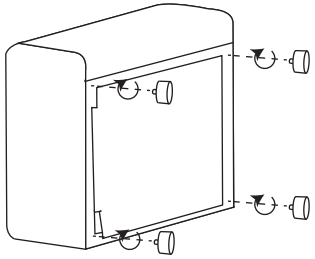

Armless Seat

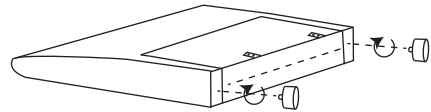

Armless Backrest

Step 5

Slide the Backrest into the Seat.

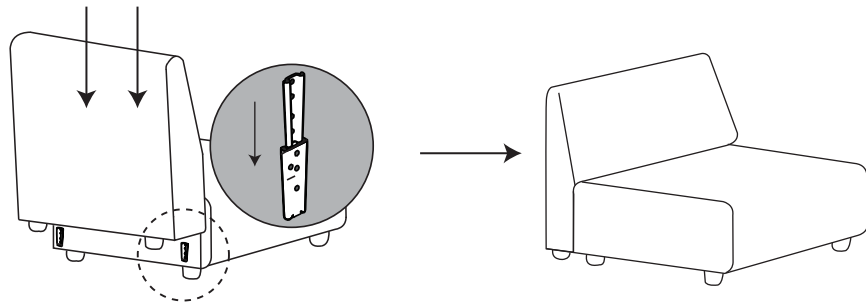

Assembly Manual

Armless Chair

Step 6

Fluff the Seat Cushion and Back Cushion, and put them on the chair to complete the assembly of your Armless Chair.

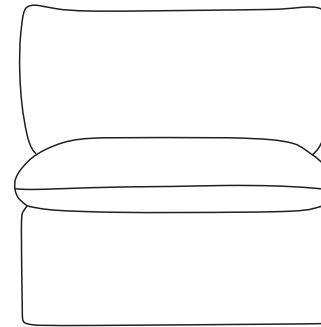

Congratulations!
Armless Chair is ready!

Assembly Manual Corner



Parts

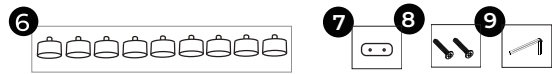
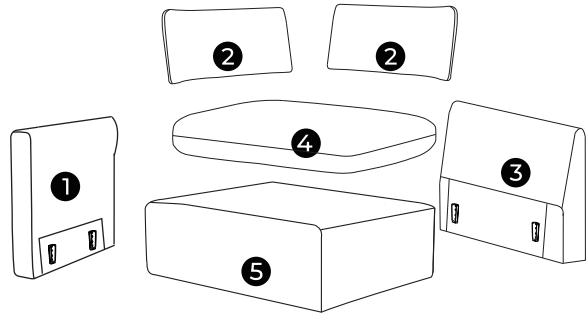

- ❶ Short Back C1
- ❷ Back Cushion x 2
- ❸ Regular Back C2
- ❹ Seat Cushion
- ❺ Seat Base
- ❻ Leg x 9
- ❼ Back Connector
- ❽ Bolt x 2
- ❾ Allen Key

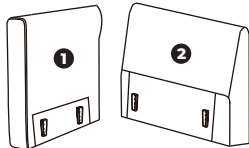
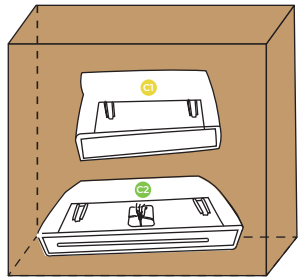

Corner Backs PIECES INCLUDED

- ❶ Short Back C1 x 1
- ❷ Regular Back C2 x 1
- ❸ Leg x 9

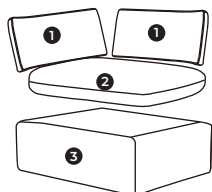
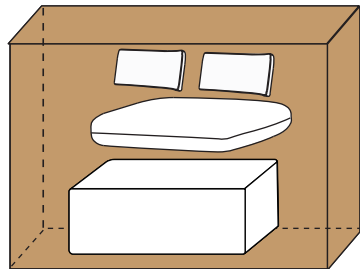

Corner Seat & Cushions PIECES INCLUDED

- ❶ Back Cushion x 2
- ❷ Seat Cushion x 1
- ❸ Seat Base x 1
- ❹ Back Connector x 1
- ❺ Bolt x 2
- ❻ Allen Key x 1
- ❼ Assembly Manual x 1



Assembly Manual Corner

Step 1

Take out the Short Back (C1) and Regular Back (C2) from Corner Backs Box.

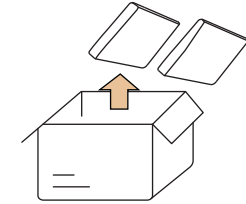
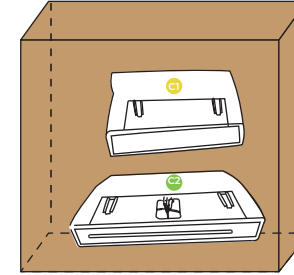

Step 2

Take out the Legs (9 pieces) from the bottom of the Regular Back (C2).

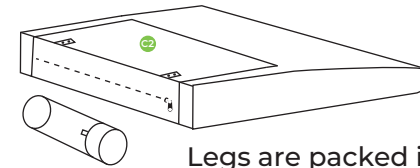

Legs are packed in a roll.



Leg x 9

Step 3

Take out the Seat Base and Back Cushions (2 pieces) from the Corner Seat & Cushions Box.

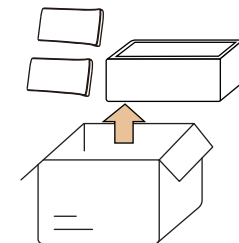
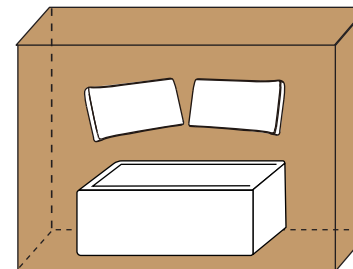

Assembly Manual

Corner

Step 4

Take out the Seat Cushion, Back Connector (1 piece), Bolts (2 pieces) and Allen Key (1 piece) from the bottom of the Seat Base.

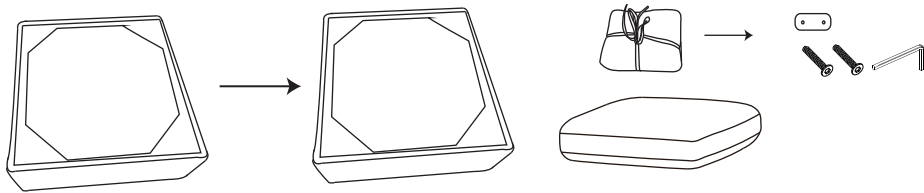

Step 5

Rotate the Legs firmly.

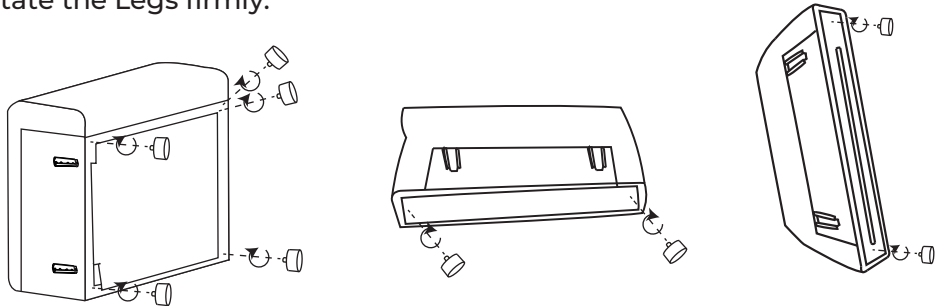

Corner Seat

Short Back

Regular Back

Step 6

Slide the Short Back (C1) into the side of Seat Base marked with C1.

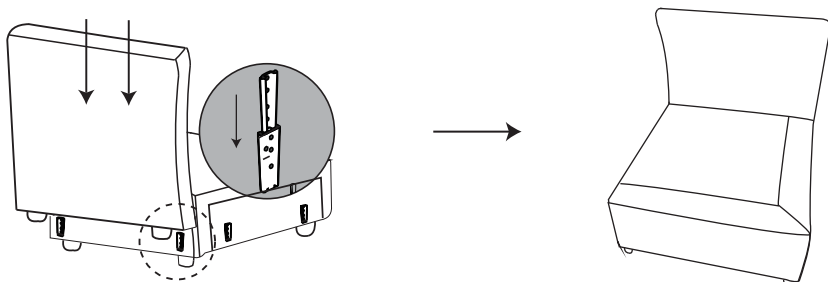

Assembly Manual

Corner

Step 7

Slide the Regular Back (C2) into the side of Seat Base marked with C2.

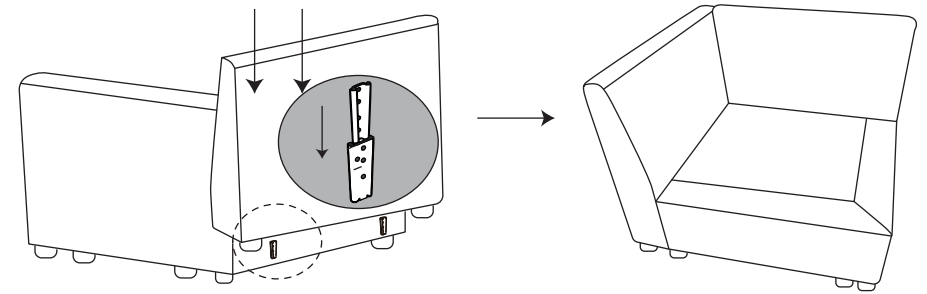

Step 8

Gently place the corner in the upright position. Attach the Back Connector, using Bolts and Allen Key. Loosely attach the bolts to get the alignment right, rather than fully tightening one before the other. After both bolts are aligned, fully tighten all bolts.

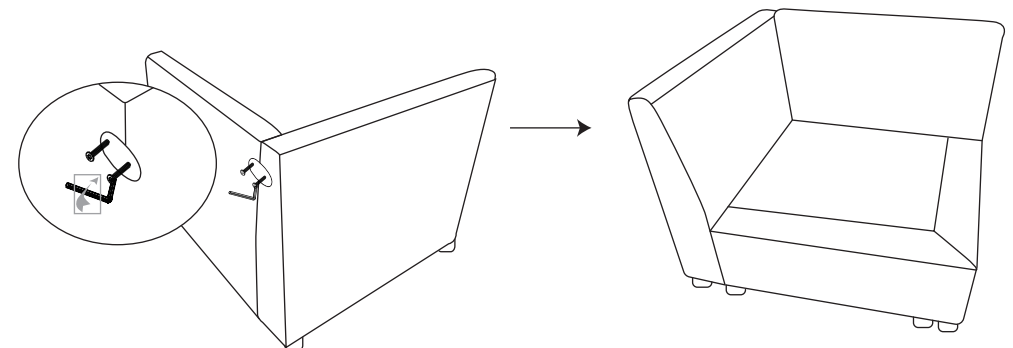

Corner

Step 9

Fluff the Seat Cushion and Back Cushions, and put them on the corner to complete the assembly.

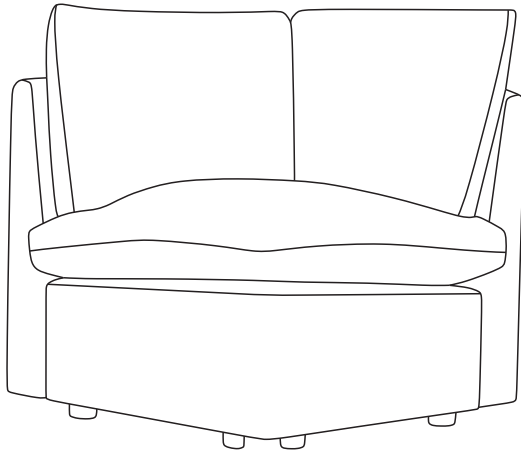

Congratulations!
Corner is ready!

Ottoman



Parts

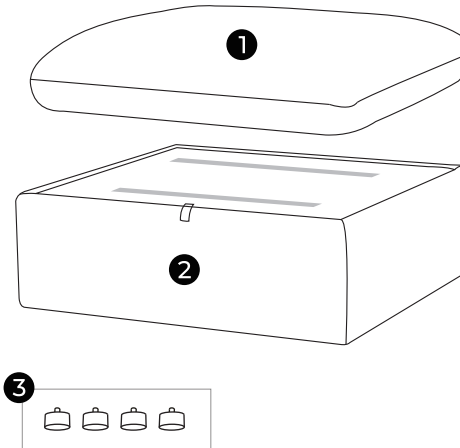

- ① Seat Cushion
- ② Seat Base
- ③ Leg x 4



Ottoman PIECES INCLUDED

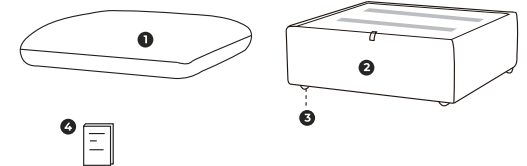
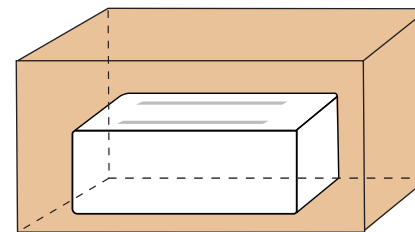

- ① Seat Cushion x 1
- ② Seat Base x 1
- ③ Leg x 4
- ④ Assembly Manual x 1

Assembly Manual

Ottoman

Step 1

Take out the Seat Base from Ottoman Box.

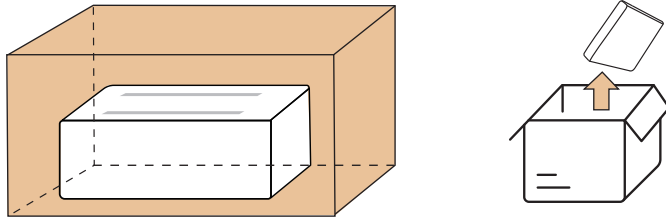

Step 2

Lift up the lid of the storage to take out Seat Cushion and Legs (4 pieces).

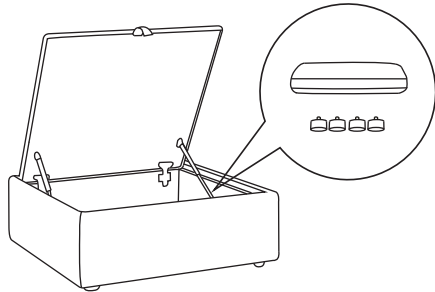

Step 3

Rotate the Legs firmly.

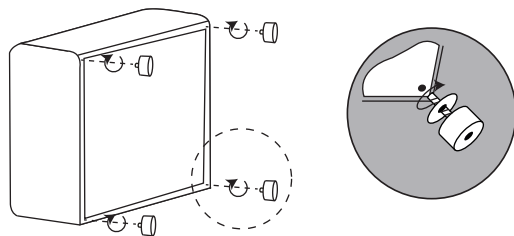

Assembly Manual

Ottoman

Step 4

Remove the velcro protectors on the top of the Seat.

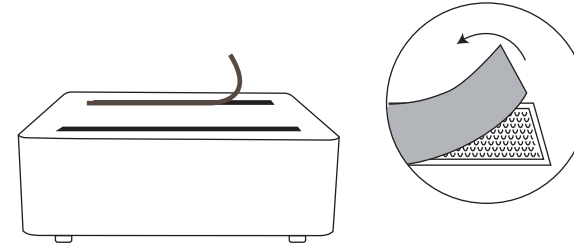

Step 5

Fluff the Seat Cushion. Attach it to the Seat Base to complete the assembly of your Ottoman.

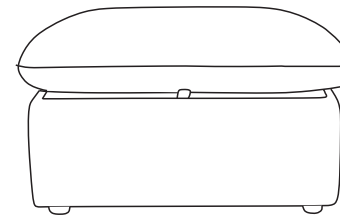

Congratulations!
Ottoman is ready!

Assembly Manual

Power Left Chair

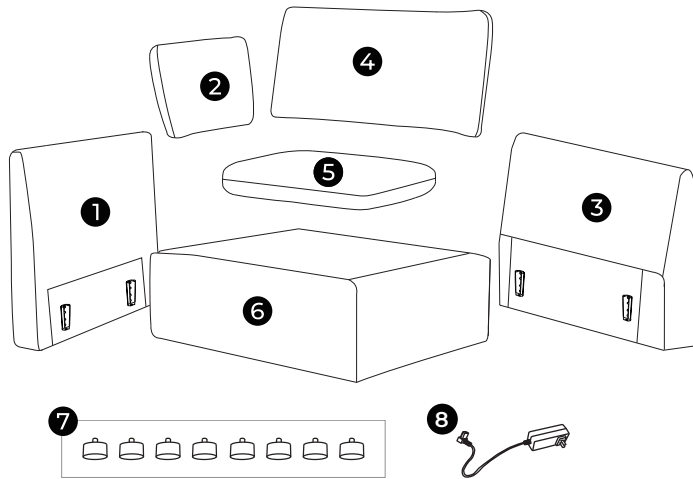

- ❶ Left Arm
- ❷ Arm Pillow
- ❸ Left Backrest
- ❹ Back Cushion
- ❺ Seat Cushion
- ❻ Left Seat Base
- ❼ Leg x 8
- ❽ Power Cord

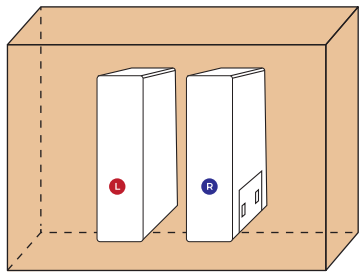

Note: Left & Right Arms are packed together in Arms Box.



Arms PIECES INCLUDED

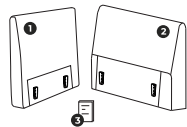

- ❶ Left Arm x 1
- ❷ Right Arm x 1
- ❸ Assembly Manual x 1

Assembly Manual

Power Left Chair

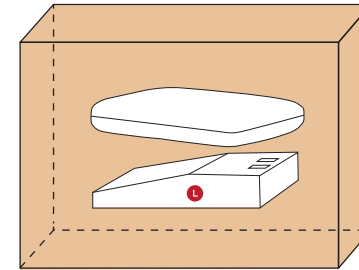

Power Left Chair Back PIECES INCLUDED

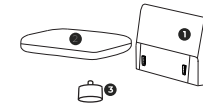

- ❶ Backrest x 1
- ❷ Seat Cushion x 1
- ❸ Leg x 8

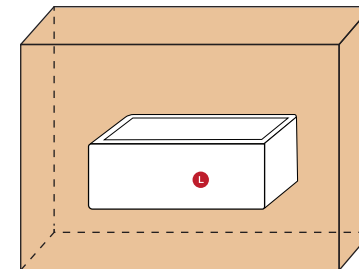

Power Left Chair Seat PIECES INCLUDED

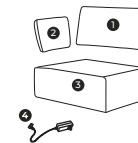

- ❶ Back Cushion x 1
- ❷ Arm Pillow x 1
- ❸ Left Seat Base x 1
- ❹ Power Cord x 1

Power Left Chair

Step 1

Take out the Left Arm (L) from Arms Box.

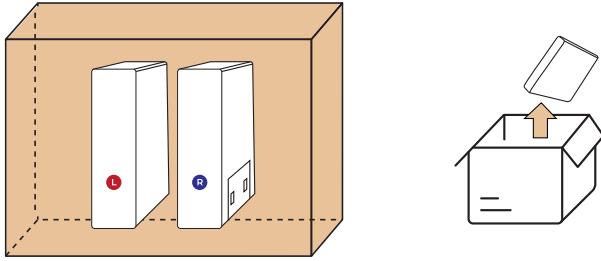

Step 2

Take out the Power Left Chair Back and the Seat Cushion from Power Left Chair Back Box.

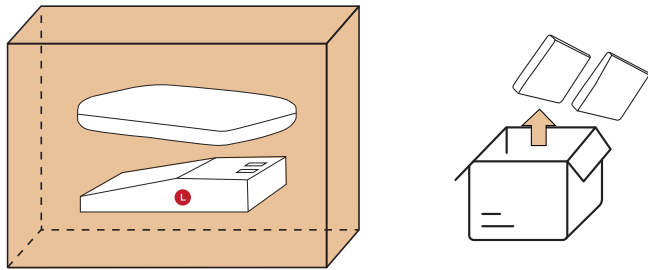

Step 3

Take out the Power Left Chair Seat from Power Left Chair Seat Box.

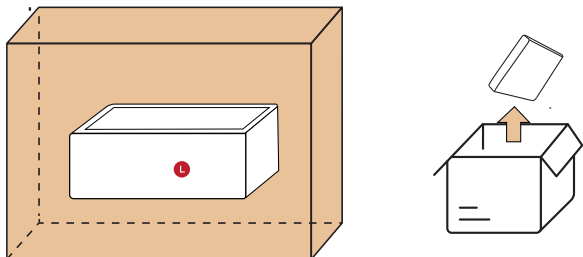

Power Left Chair

Step 4

Locate the Back Cushion Case and the Arm Pillow Case at the top of the seat base.

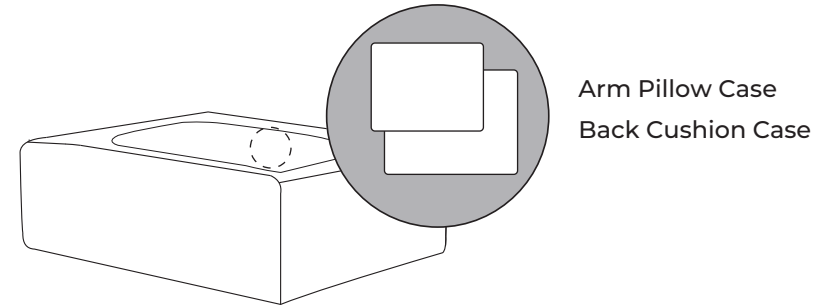

Step 5

Locate the Power Cord, Back Cushion Insert and Arm Pillow Insert at the bottom of the seat, then take them out carefully.

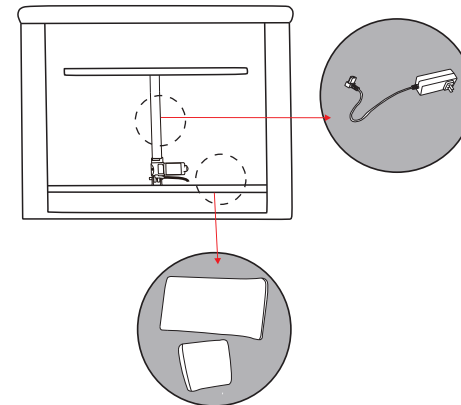

Power Left Chair

Step 6

Take out the Legs (8 pieces) from the bottom of the Backrest.

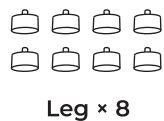
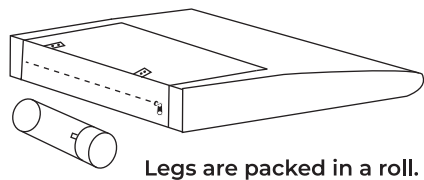

Step 7

Rotate the Legs firmly.

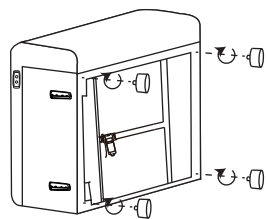

Power Left Chair Seat

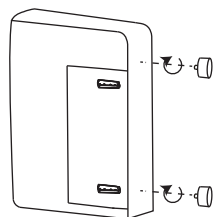

Left Arm

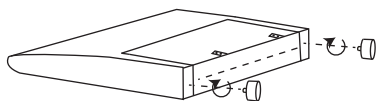

Power Left Chair Back

Step 8

Connect the cable on the seat base into the cable on the backrest, and lock up.

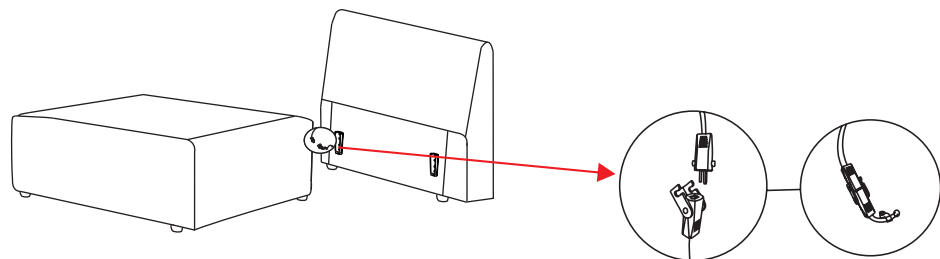

Power Left Chair

Step 9

Slide the Power Left Chair Back into the Power Left Chair Seat.

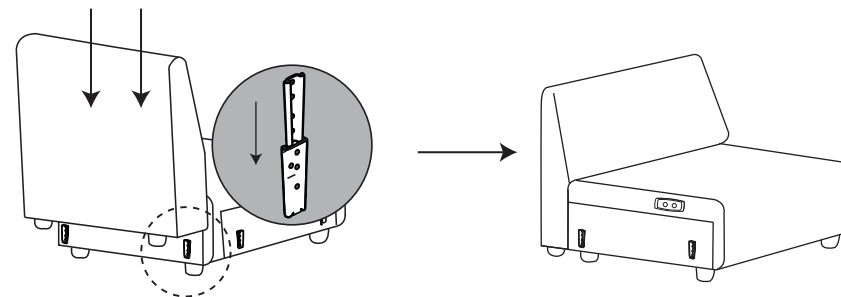

Step 10

Slide the Left Arm into the Power Left Chair Seat and Back.

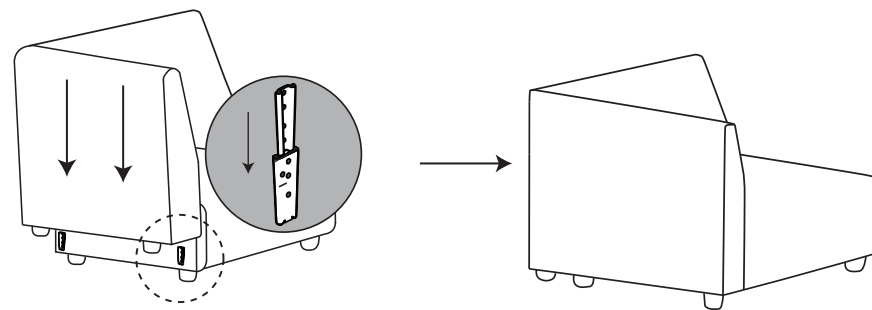

Power Left Chair

Step 11

Insert the Back Cushion Core into the Back Cushion Case and the Arm Pillow Core into the Arm Pillow Case. Fluff the Seat Cushion, Back Cushion, and Arm Pillow, and put them on the chair to complete the assembly of your Power Left Chair.

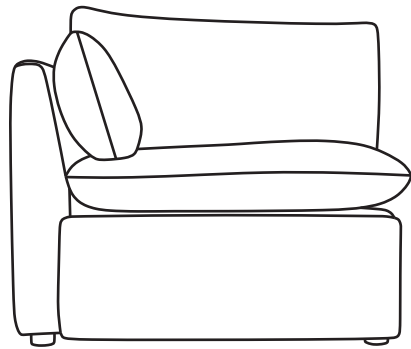
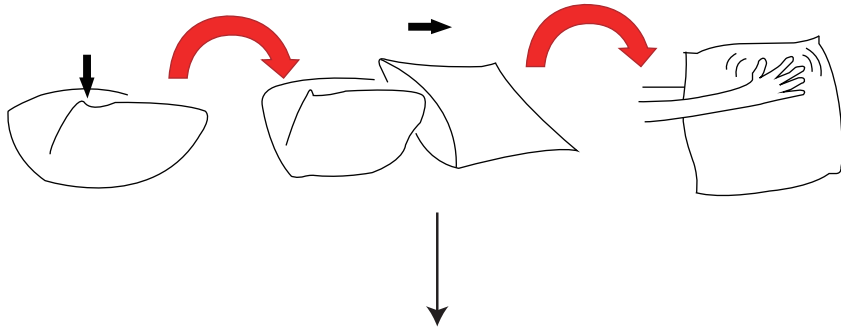

Congratulations!
Power Left Chair is ready!

Power Right Chair



Parts

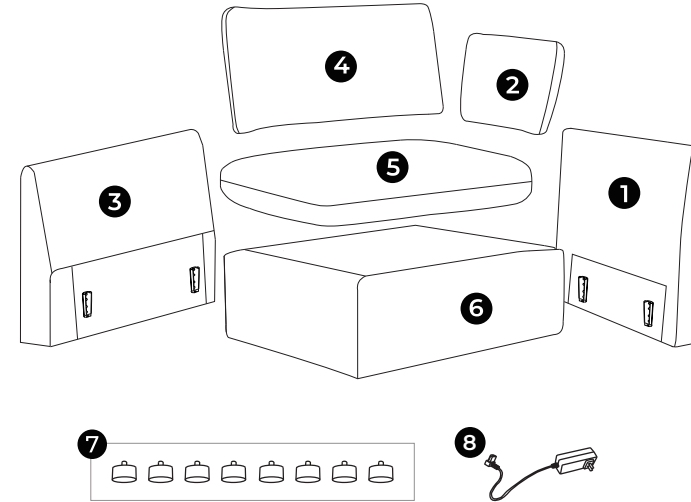

- 1 Right Arm
- 2 Arm Pillow
- 3 Right Backrest
- 4 Back Cushion
- 5 Seat Cushion
- 6 Right Seat Base
- 7 Leg x 8
- 8 Power Cord

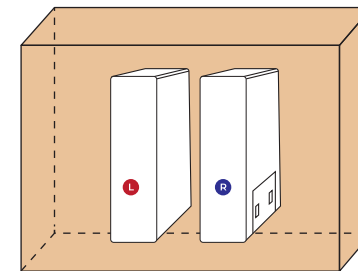

Arms PIECES INCLUDED

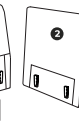
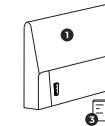

- 1 Left Arm x 1
- 2 Right Arm x 1
- 3 Assembly Manual x 1

Note: Left & Right Arms are packed together in Arms Box.

Power Right Chair

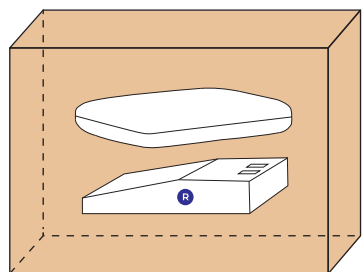

Power Right Chair Back PIECES INCLUDED

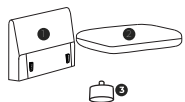

- ❶ Backrest x 1
- ❷ Seat Cushion x 1
- ❸ Leg x 8

Power Right Chair

Step 1

Take out the Right Arm (R) from Arms Box.

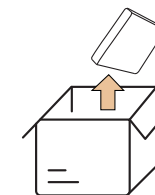
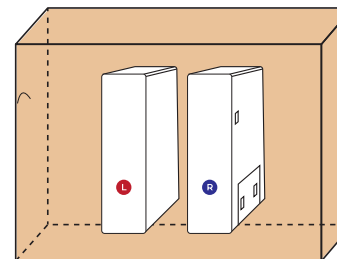

Step 2

Take out the Power Right Chair Back and the Seat Cushion from Power Right Chair Back Box.

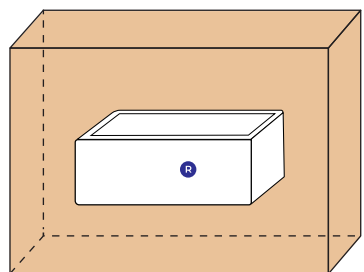
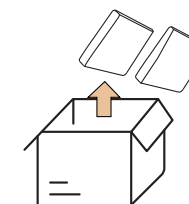
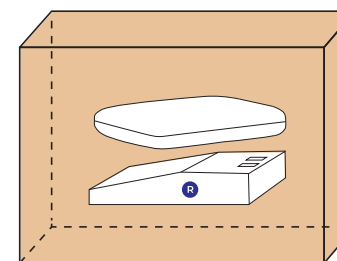

Power Right Chair Seat PIECES INCLUDED

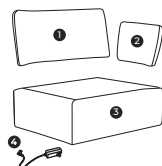

- ❶ Back Cushion x 1
- ❷ Arm Pillow x 1
- ❸ Right Seat Base x 1
- ❹ Power Cord x 1

Step 3

Take out the Power Right Chair Seat from Power Right Chair Seat Box.

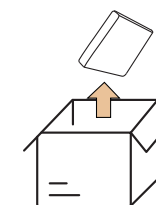
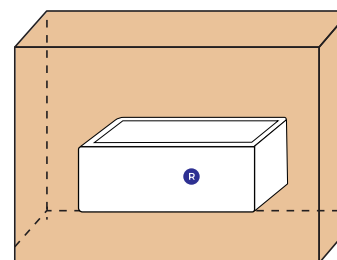

Power Right Chair

Step 4

Locate the Back Cushion Case and the Arm Pillow Case at the top of the seat base.

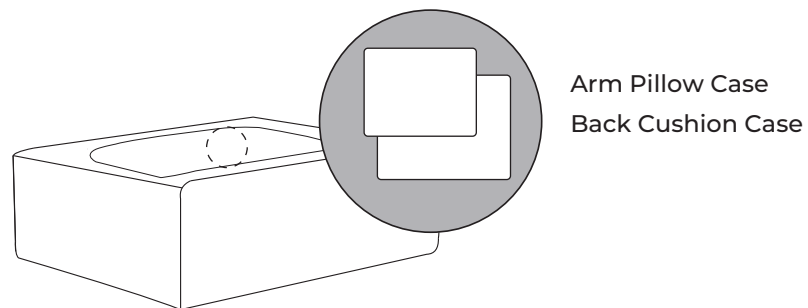

Step 5

Locate the Power Cord, Back Cushion Insert and Arm Pillow Insert at the bottom of the seat, then take them out carefully.

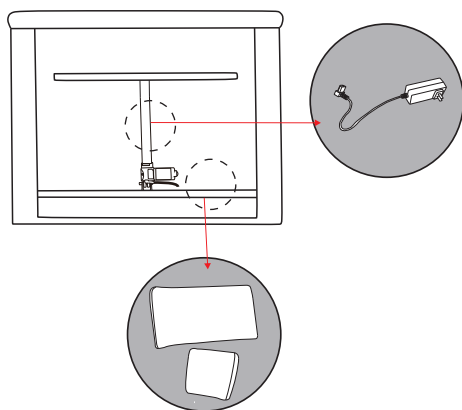

Power Right Chair

Step 6

Take out the Legs (8 pieces) from the bottom of the Backrest.

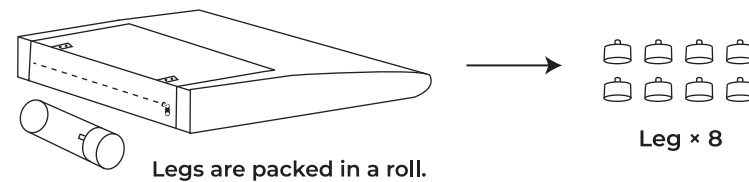

Step 7

Rotate the Legs firmly.

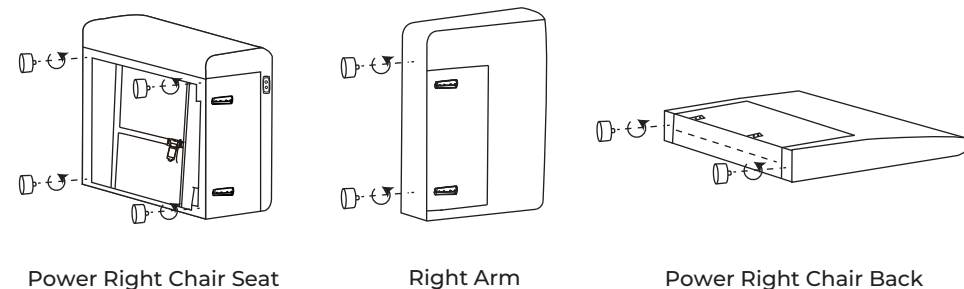

Step 8

Connect the cable on the seat base into the cable on the backrest, and lock up.

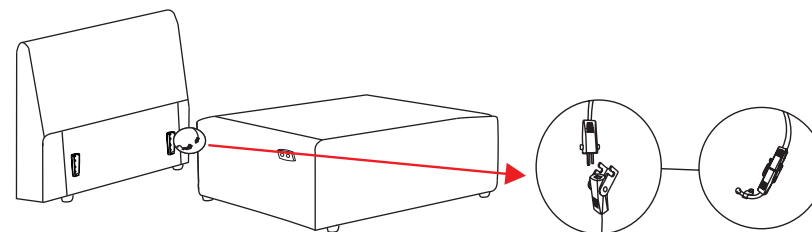

Power Right Chair

Step 9

Slide the Power Right Chair Back into the Power Right Chair Seat.

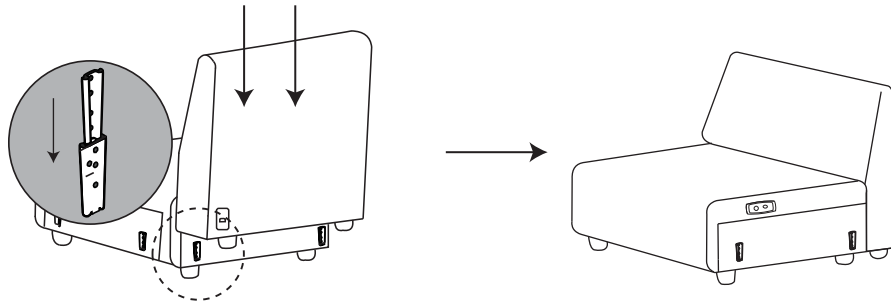

Step 10

Slide the Right Arm into the Power Right Chair Seat and Back.

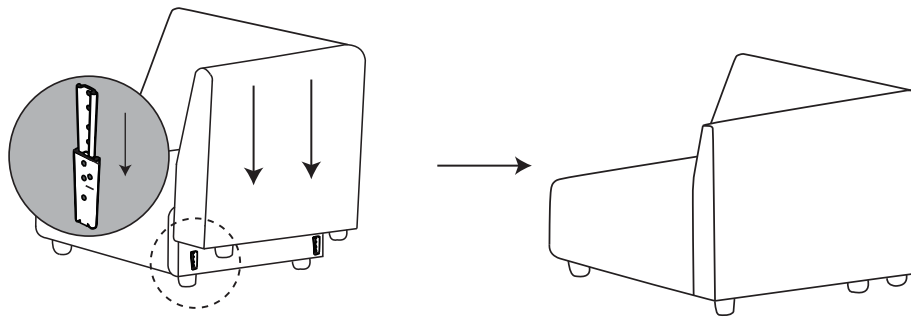

Power Right Chair

Step 11

Insert the Back Cushion Core into the Back Cushion Case and the Arm Pillow Core into the Arm Pillow Case. Fluff the Seat Cushion, Back Cushion, and Arm Pillow, and put them on the chair to complete the assembly of your Power Right Chair.

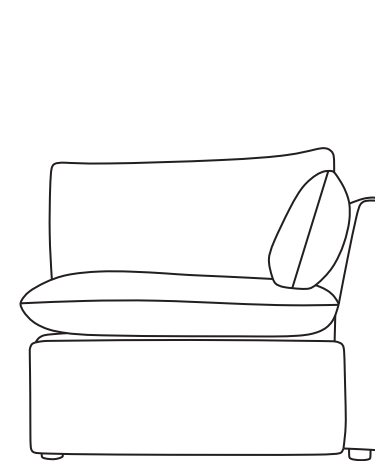
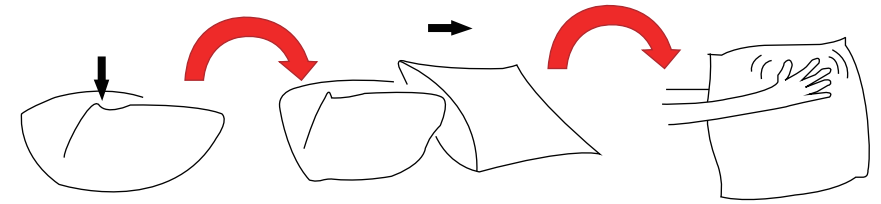

Congratulations!
Power Right Chair is ready!

Power Armless Chair

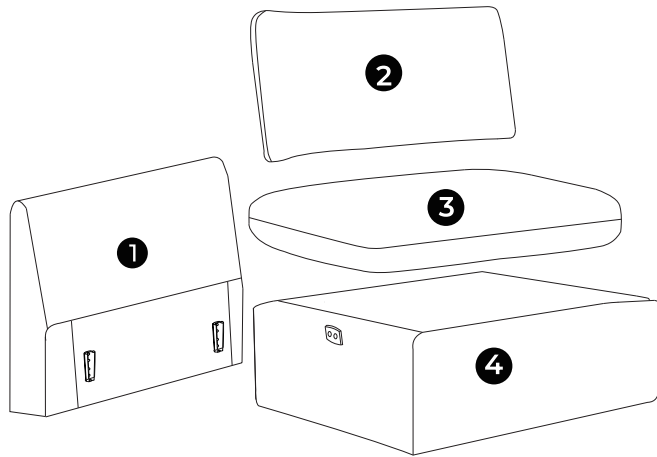

- 1 Backrest
- 2 Back Cushion
- 3 Seat Cushion
- 4 Seat Base
- 5 Leg x 6

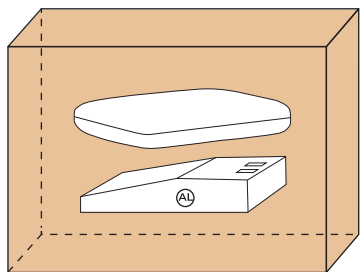

Power Armless Chair Back
PIECES INCLUDED

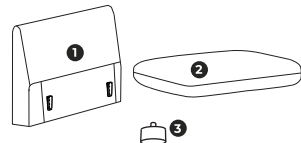

1 Backrest x 1

2 Seat Cushion x 1

3 Leg x 6

Power Armless Chair

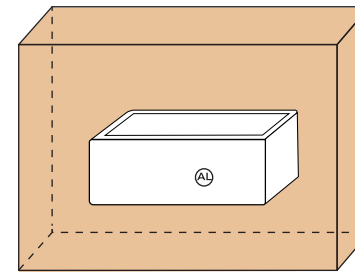

Power Armless Chair Seat
PIECES INCLUDED

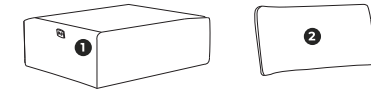

1 Seat Base x 1

2 Back Cushion x 1

Step 1

Take out the Backrest and the Seat Cushion from Power Armless Chair Back Box.

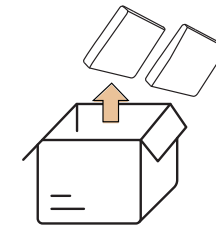
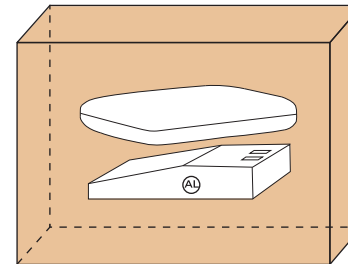

Step 2

Take out the Power Armless Chair Seat from Power Armless Chair Seat Box.

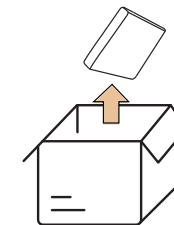
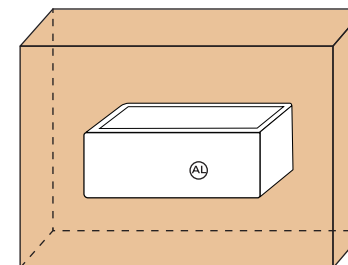

Power Armless Chair

Step 3

Locate the Back Cushion Case at the top of seat base.

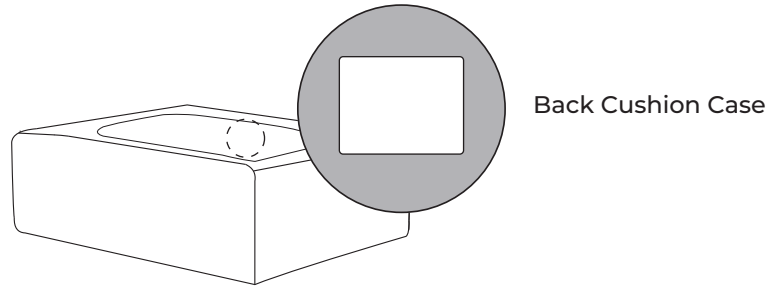

Step 4

Locate the Back Cushion insert at the bottom of the seat, then take it out carefully.

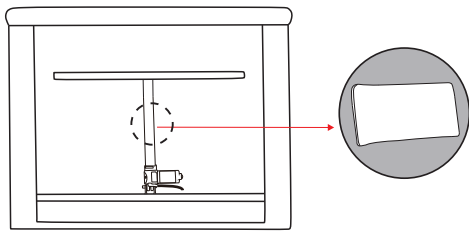

Step 5

Take out the Legs (6 pieces) from the bottom of the Backrest.

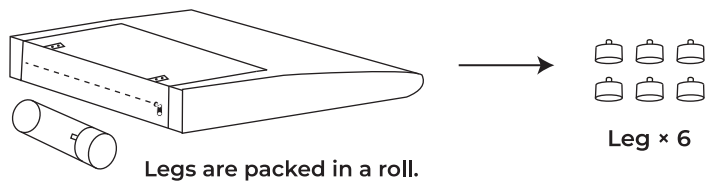

Power Armless Chair

Step 6

Rotate the Legs firmly.

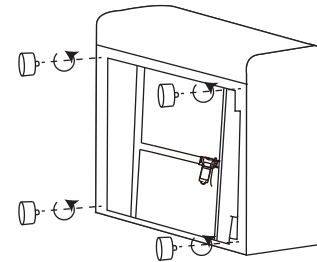

Power Armless Chair Seat

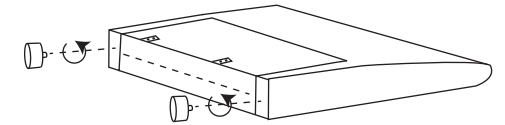

Power Armless Chair Back

Step 7

Slide the Power Armless Chair Back into the Power Armless Chair Seat.

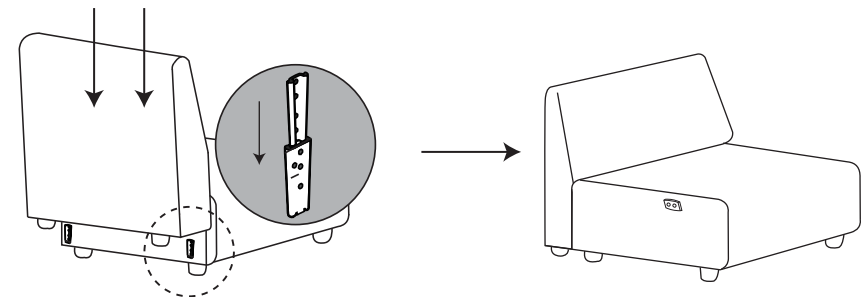

Power Armless Chair

Step 8

Insert the Back Cushion Core into the Back Cushion Case. Fluff the Seat Cushion and Back Cushion, and put them on the chair to complete the assembly of your Power Armless Chair.

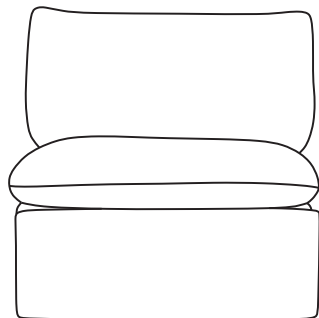
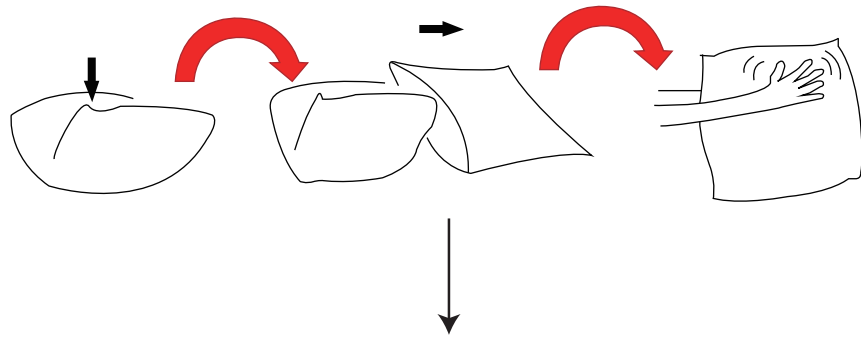

Congratulations!
Power Armless Chair is ready!

Armless Recliner



Parts

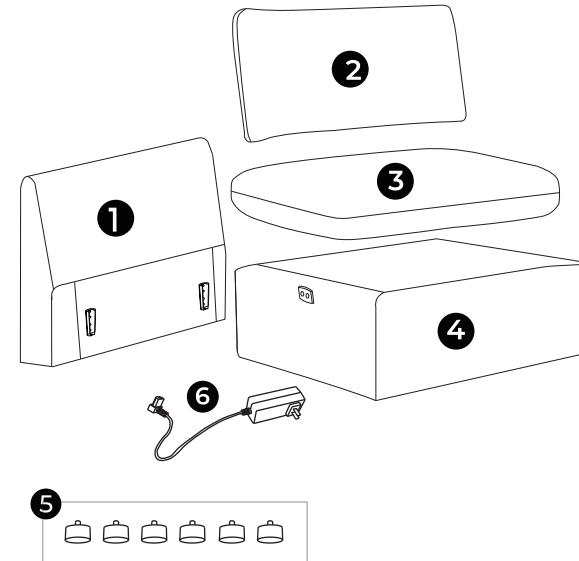

- ① Backrest
- ② Back Cushion
- ③ Seat Cushion
- ④ Seat Base
- ⑤ Leg x 6
- ⑥ Power Cord

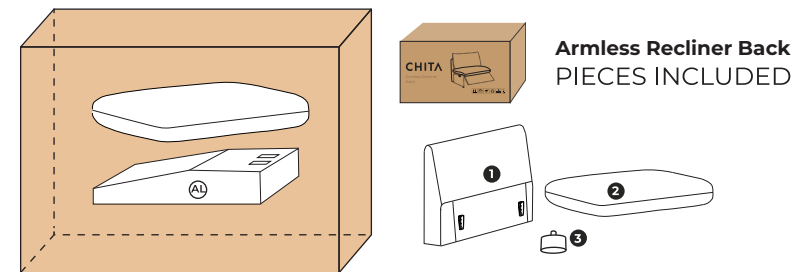

- ① Backrest x 1
- ② Seat Cushion x 1
- ③ Leg x 6

Assembly Manual

Armless Recliner

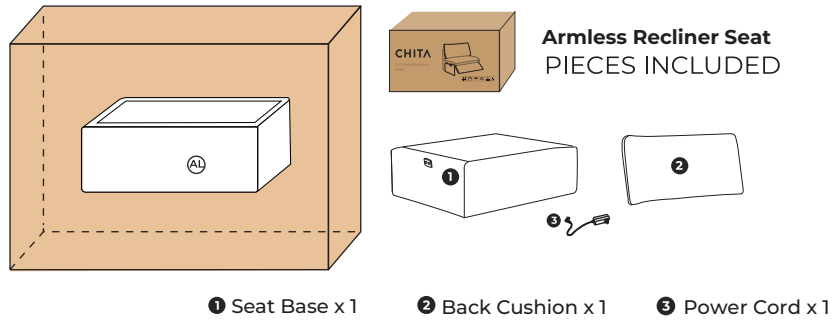

Step 1

Take out the Backrest and the Seat Cushion from Armless Recliner Back Box.

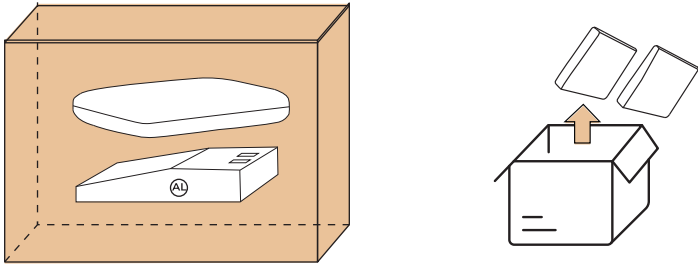

Step 2

Take out the Armless Recliner Seat from Armless Recliner Seat Box.

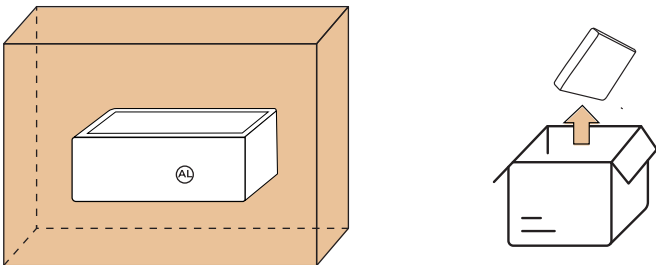

Assembly Manual

Armless Recliner

Step 3

Locate the Back Cushion Case at the top of seat base.

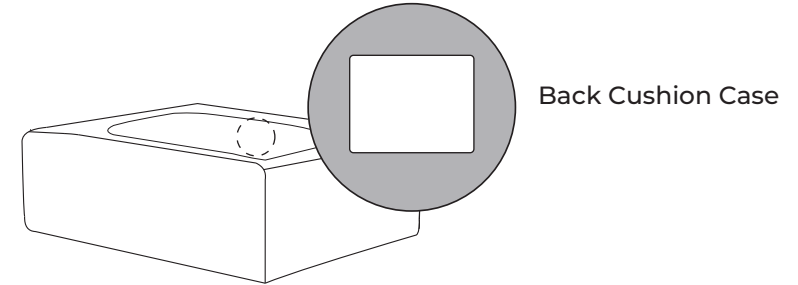

Step 4

Locate the Power Cord and the Back Cushion Insert at the bottom of the seat, then take them out carefully.

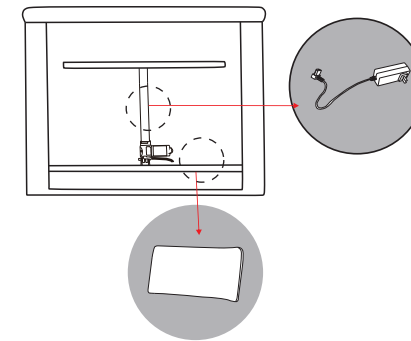

Step 5

Take out the Legs (6 pieces) from the bottom of the Backrest.

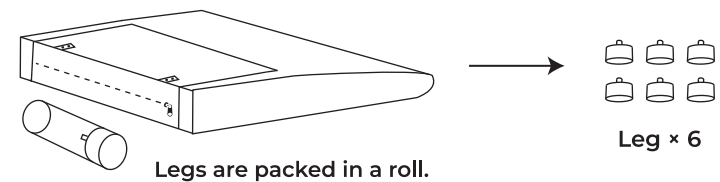

Armless Recliner

Step 6

Rotate the Legs firmly.

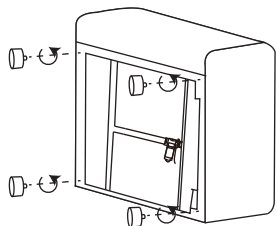

Power Armless Chair Seat

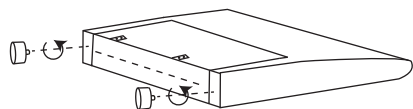

Power Armless Chair Back

Step 7

Connect the cable on the seat base into the cable on the backrest, and lock up.

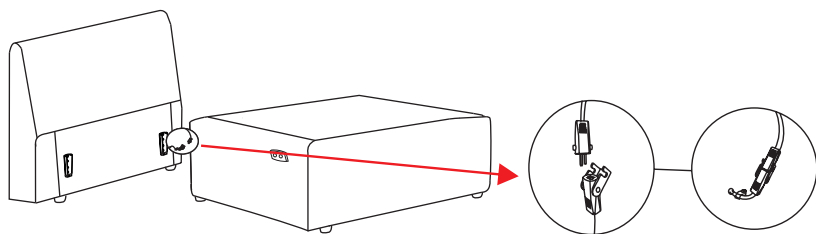

Step 8

Slide the Armless Recliner Back into the Armless Recliner Seat.

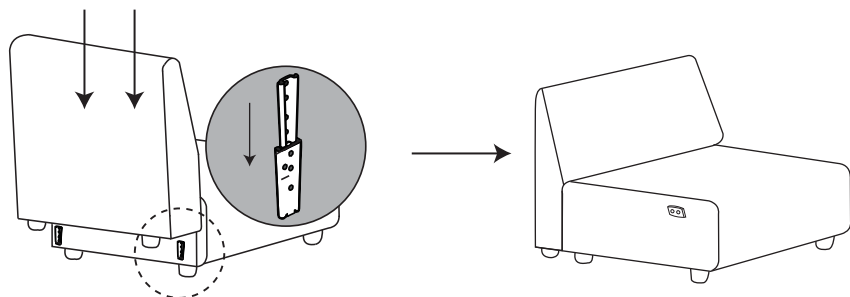

Armless Recliner

Step 9

Insert the Back Cushion Core into the Back Cushion Case. Fluff the Seat Cushion and Back Cushion, and put them on the chair to complete the assembly of your Armless Recliner.

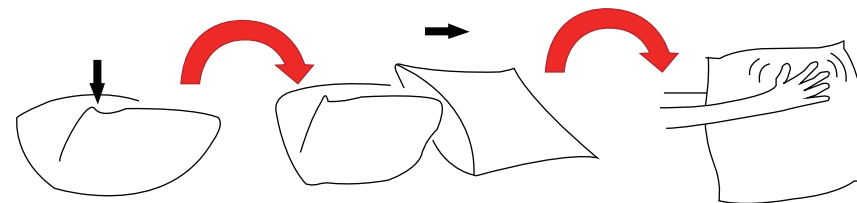

Step 10

Connect one end of the power cord into the DC adaptor located at the back of the seat. Plug the other end of power cord into the power outlet.

Note: After all the connections are made, the green LED will be lit up.

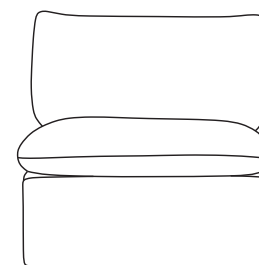
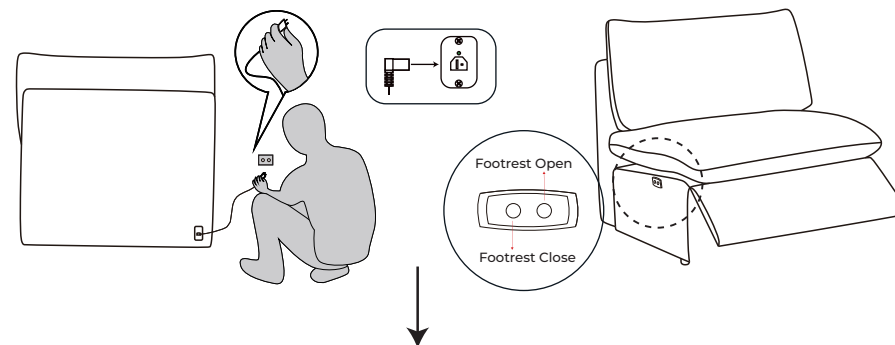

Congratulations!
Armless Recliner is ready!

How to Connect

Step 1

Connect the wire piece by piece.

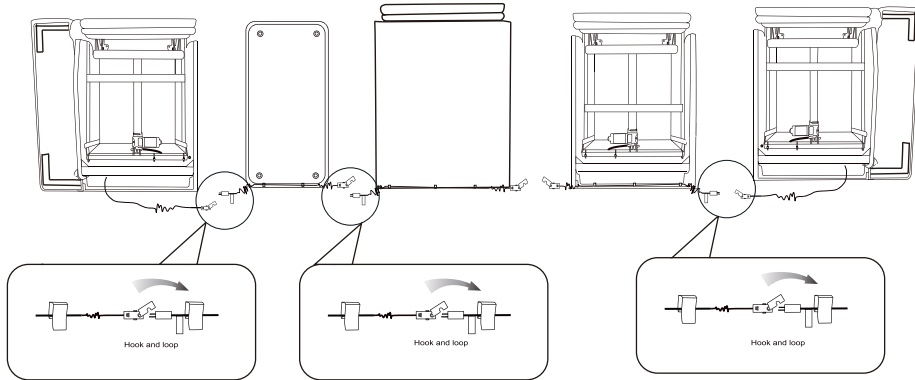

Step 2

Plug the power cord of either the left or right power armchair into the power outlet.

Note: After all the connections are made, the green LED will be lit up.

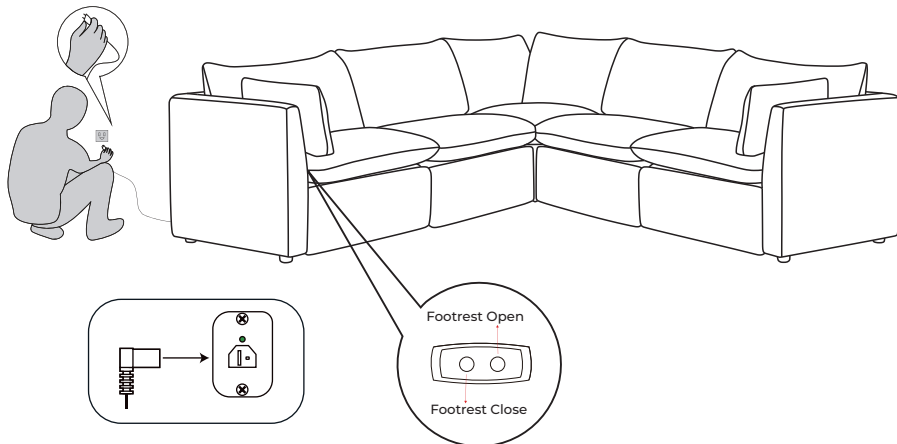

Modular Sofa Multiple Configurations

2-piece Armless



W 68" x D 35" x H 35"

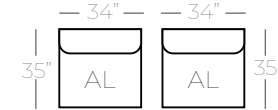

2-piece Sofa



W 80" x D 35" x H 35"



3-piece Sofa



W 114" x D 35" x H 35"

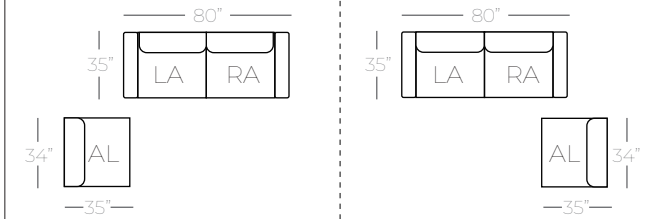

4-piece Sofa-Chaise



W 114" x D 68" x H 35"

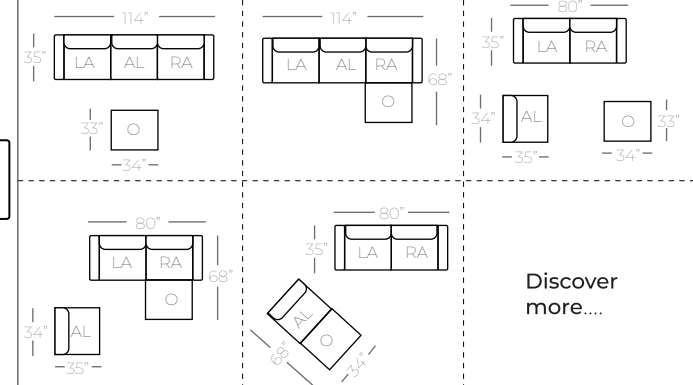

Discover more....

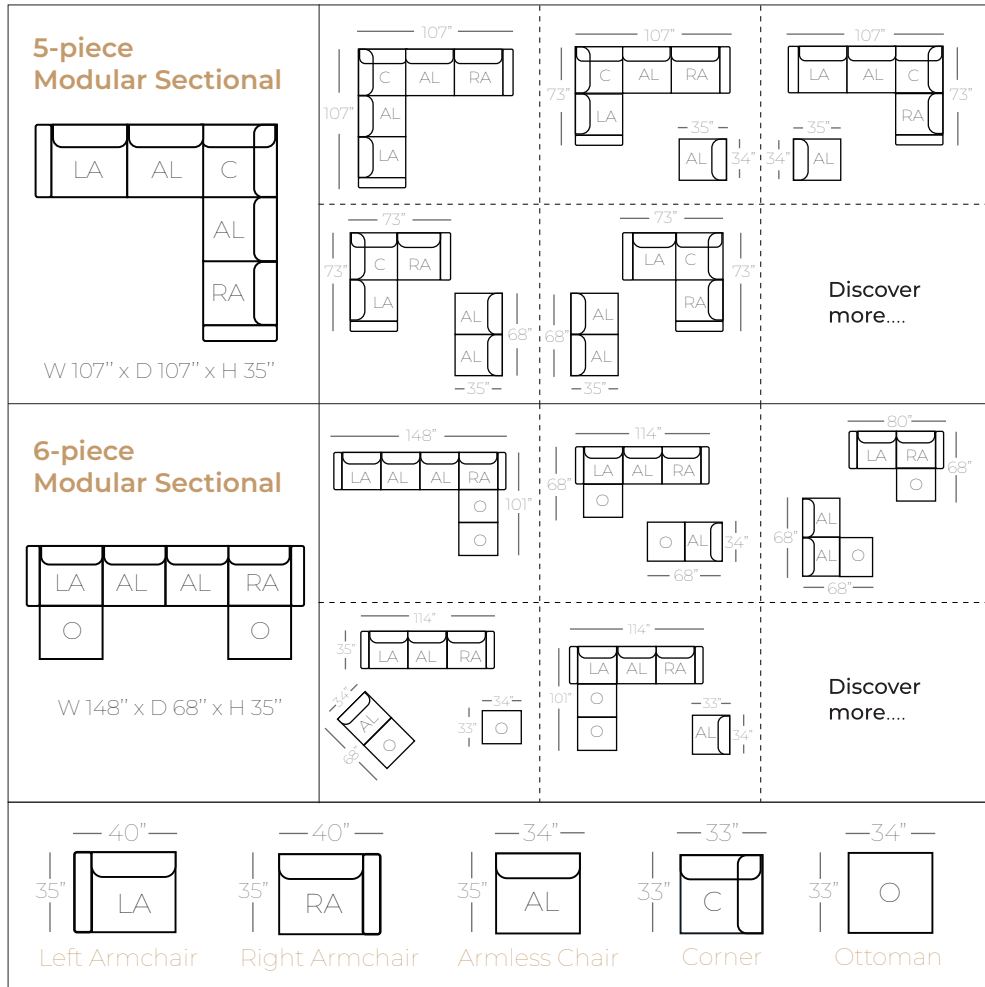

Discover more....

Discover more....

Care Instruction

For non-removable areas:

Blot and spot clean immediately with a clean, absorbent cloth and a water-free stain remover (Cleaning Code: S).

For cushion covers:

- Ⓟ Dry clean only.
- ☒ Do not tumble dry.
- ☒ Do not bleach.
- ☒ Iron at low temperature (230°F / 110°C or below).