

M-79098

Assembly Manual

Power Recliner Armchair

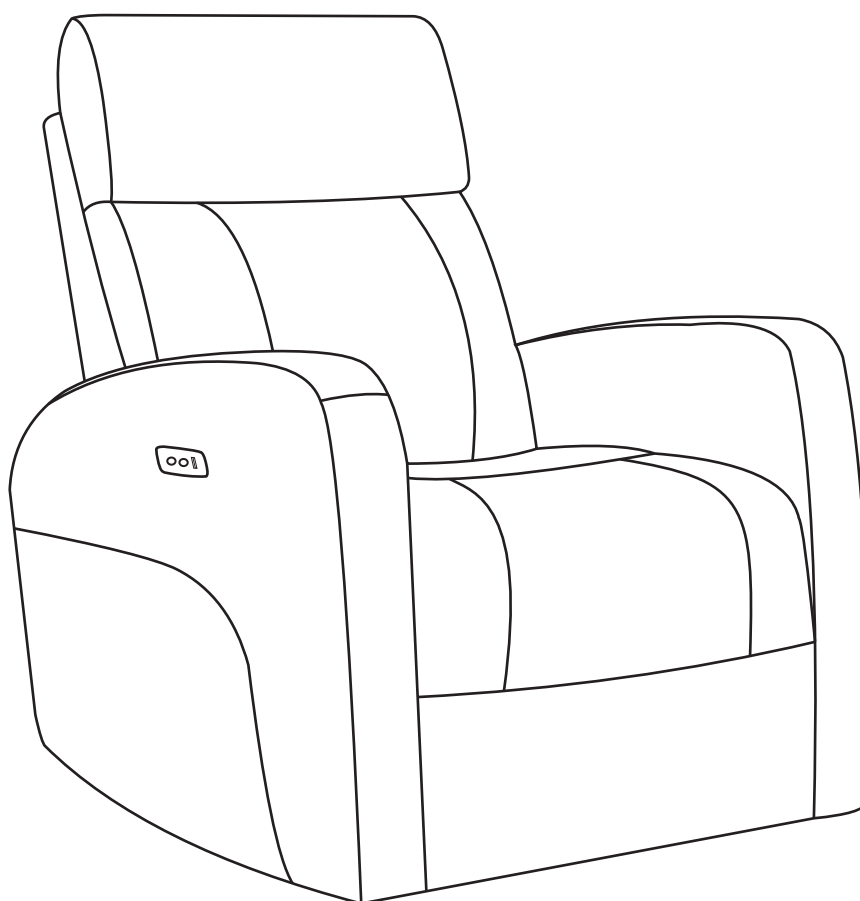

CAUTION

THIS ASSEMBLY MANUAL CONTAINS IMPORTANT SAFETY INFORMATION.

PLEASE READ AND KEEP FOR FUTURE REFERENCE.

COMPONENTS

A Chair Back
1X

B Chair Base
1X

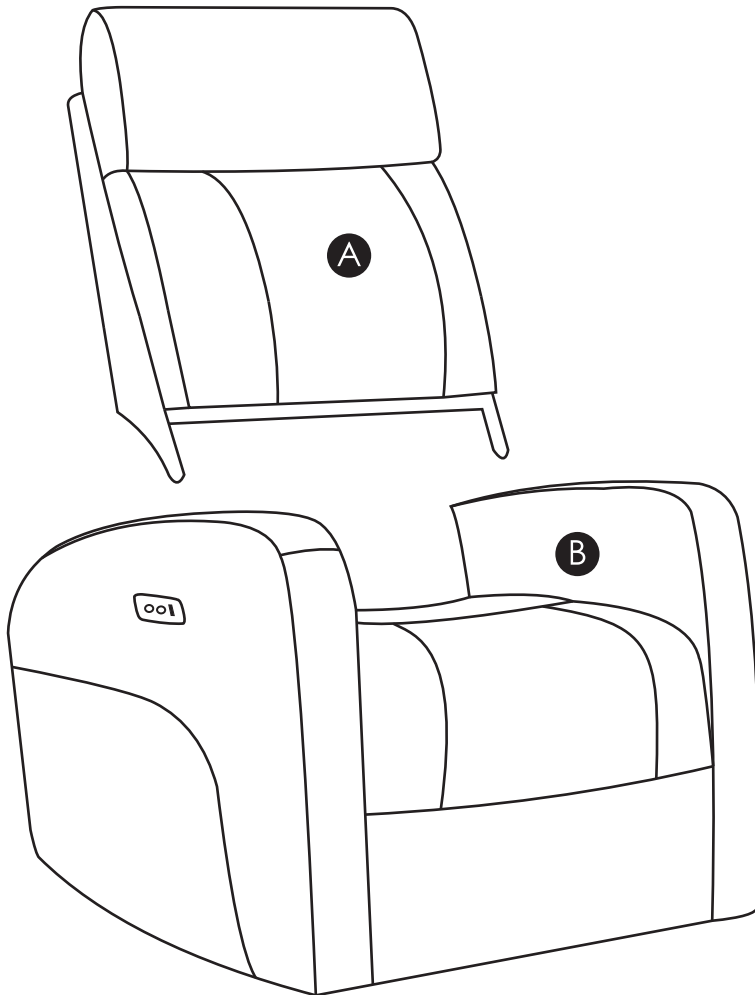

WARNING

Find a yellow protector at the bottom, then remove it before using.

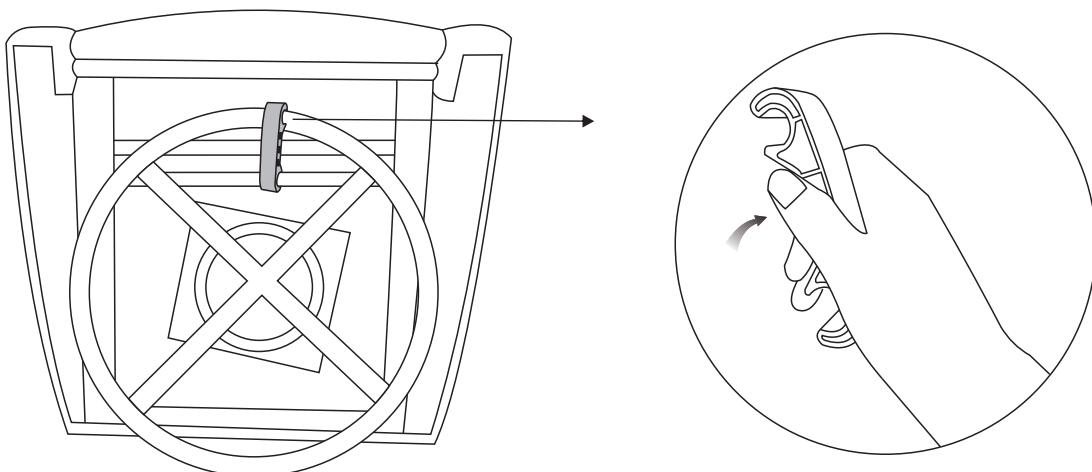

ASSEMBLY INSTRUCTIONS

1

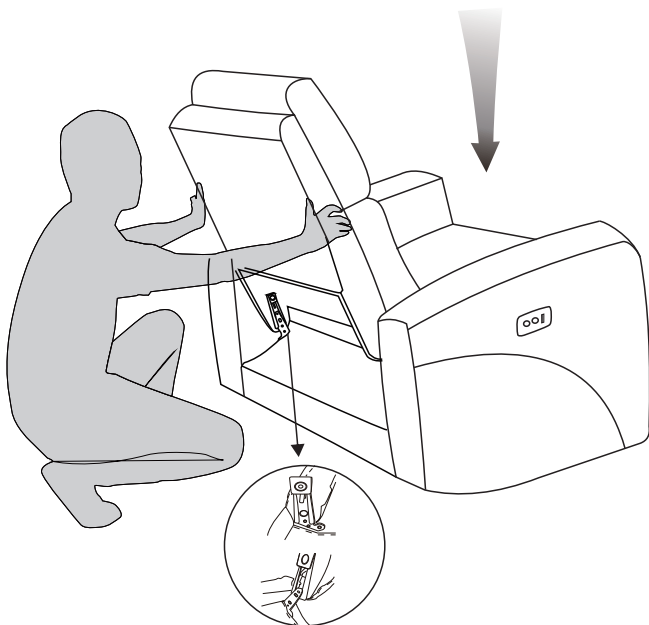

Align seat back and frame to metallic quick connectors and slide into place.

2

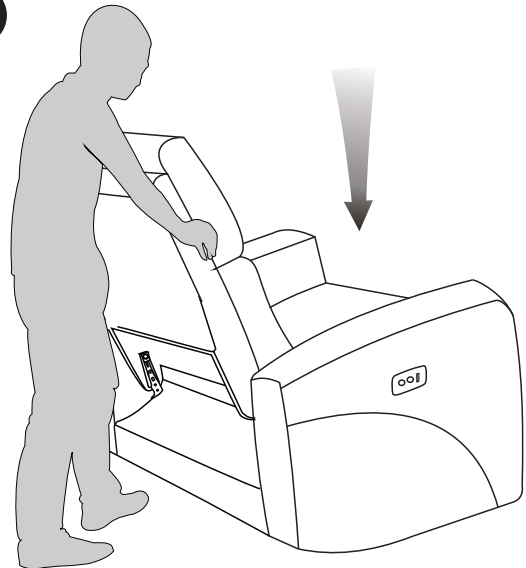

Push down firmly on seat back to lock connector

3

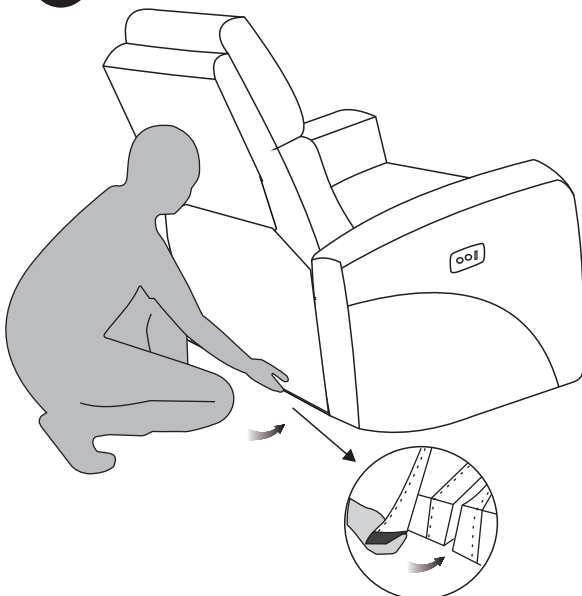

Affix back cover to bottom of the frame using the built-in hook and loop fastener strip.

4

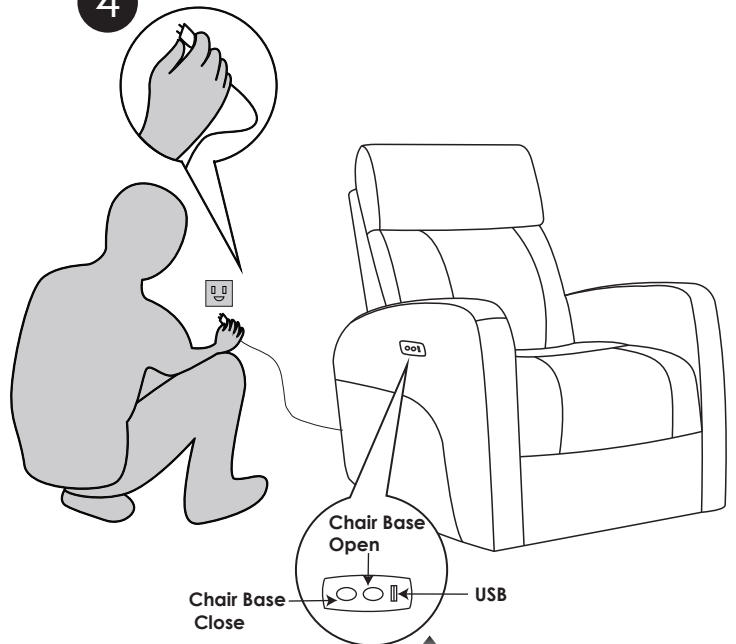

? How to operate

Put the plug into the power outlet.

PRODUCT WARRANTY

- 1-year limited on leather against splitting, peeling, and/or tearing.
- 1-year limited on internal and external frame structure.
- 1-year limited on cushioning material, seat springs and mechanism.

CARE & MAINTENANCE

Periodic dusting will prolong the life of your leather.

General cleaning can be done with a damp, clean, soft white cloth.

Periodically, a mild leather cleaner can be used on the headrests and armrests. This will help prevent buildup of body and hair oils which can harm the leather over time.

For more stubborn stains, a mild leather cleaner can be used or consult a professional leather technician.

CONTACT US



CHITA CONSUMER CARE

All of us at CHITA thank you for being a valued customer. If you have any questions or concerns, please contact CHITA consumer care. We will respond within 24 business hours.

Email: contactus@chitaliving.com

 [@chitaliving](https://www.facebook.com/chitaliving)

CHITA FEEDBACK

Your feedback is very important to our company as we constantly strive to improve our products and services.

If possible, CHITA would sincerely appreciate if you can provide an honest review on our product and shopping experience.

