

KF-Y2005 Assembly Manual

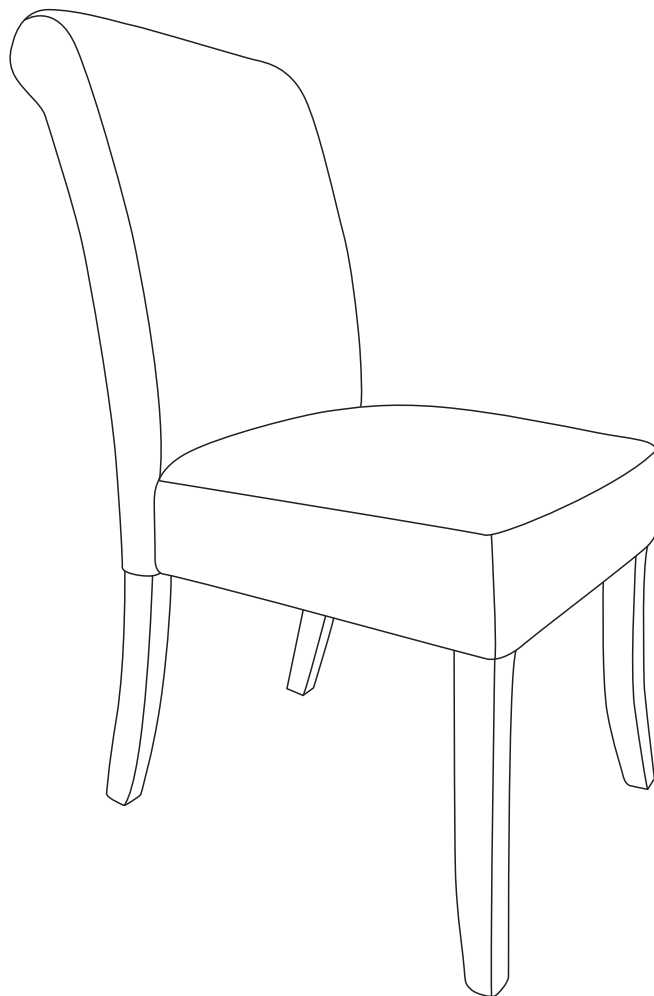



Dining Chair

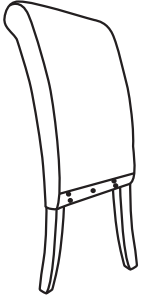
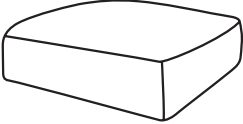
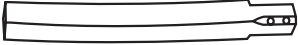

▲ CAUTION

THIS ASSEMBLY MANUAL CONTAINS IMPORTANT SAFETY INFORMATION.

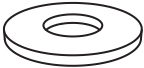
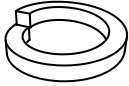
PLEASE READ AND KEEP FOR FUTURE REFERENCE.

<p>Ax1</p>  <p>Back</p>	<p>Bx1</p>  <p>Seat</p>
<p>Cx2</p>  <p>Front Leg</p>	<p>H1x9</p>  <p>Bolt (M8 x 65mm)</p>
<p>H2x9</p>  <p>Flat Washer</p>	<p>H3x9</p>  <p>Lock Washer</p>
<p>H4x1</p>  <p>Allen Key</p>	

ASSEMBLY INSTRUCTIONS

- 1 Remove the hardware package and the front legs from the underneath pocket of the upholstered seat.

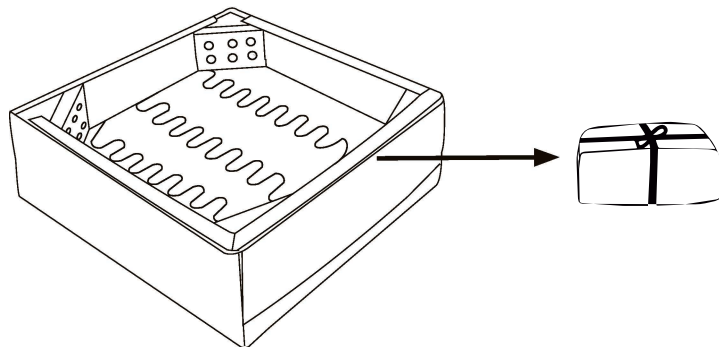

- 2 Attach seat (B) to back (A), using bolt (H1), lock washers (H3), flat washers (H2), and allen wrench (H4).

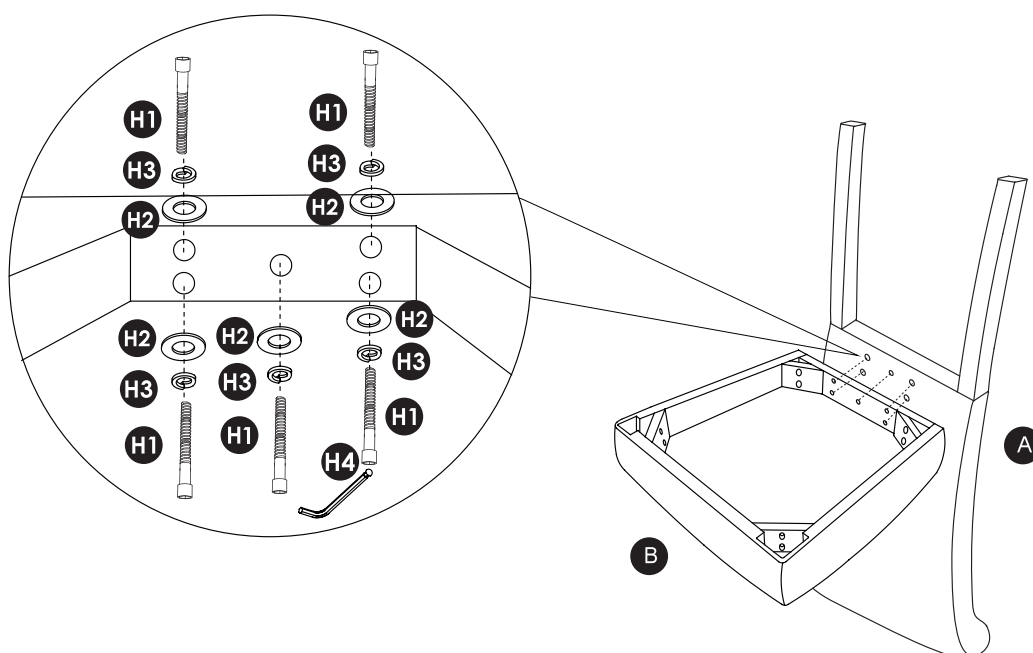

- 3** Attach front legs (C) to seat (B), using short bolts (H1), lock washers (H3), flat washers (H2), and allen wrench (H4).
Note: Do not fully tighten yet.

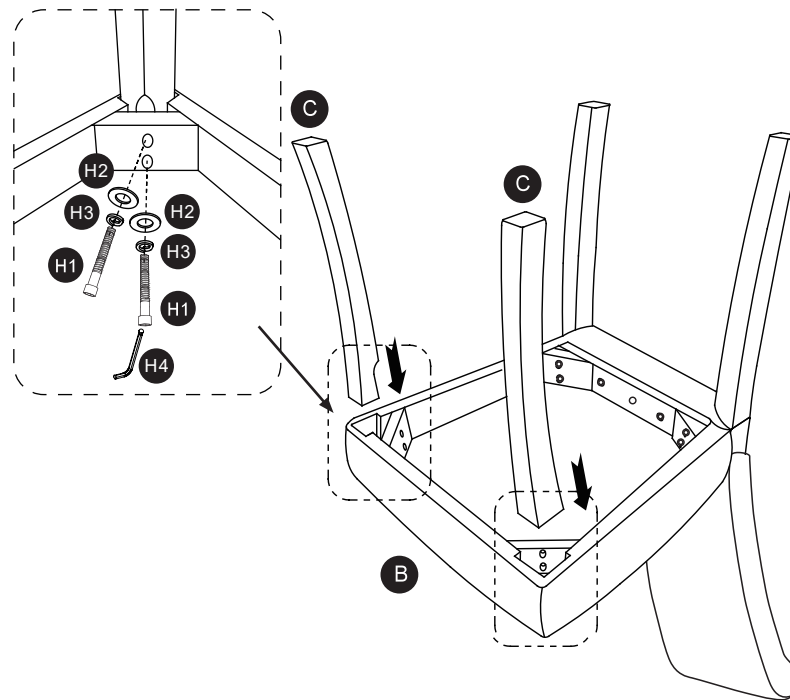

- 4** Turn assembled chair upright and place on a flat surface. Push legs up or down as necessary to level. **Once level, tighten all bolts.**

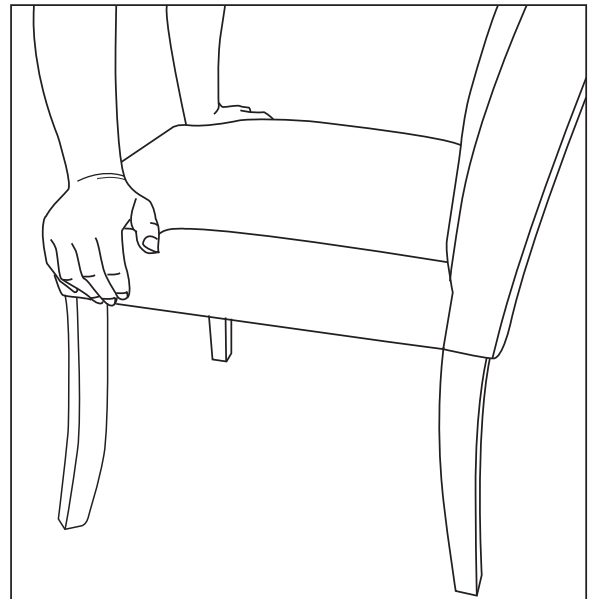
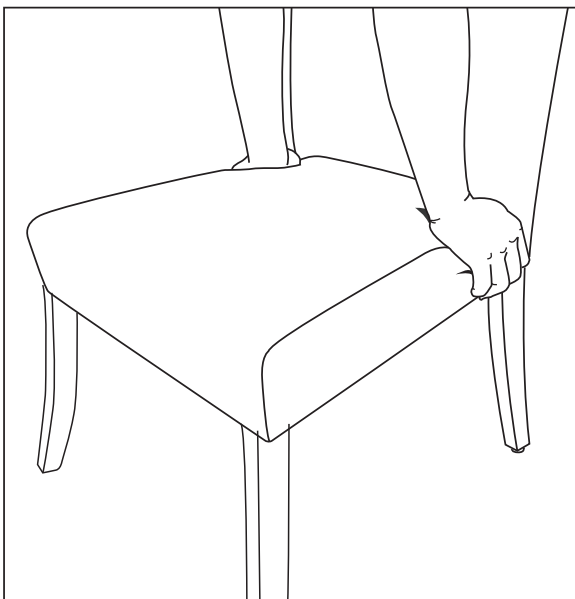

-
- 5** Attach the dust cover to the seat.

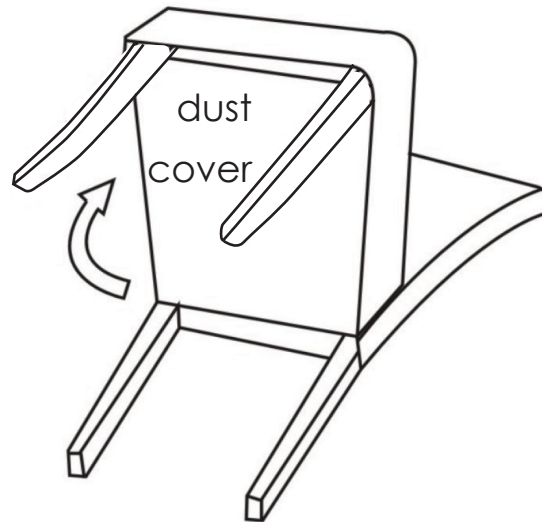

- 6** Assembly complete. Enjoy.

