

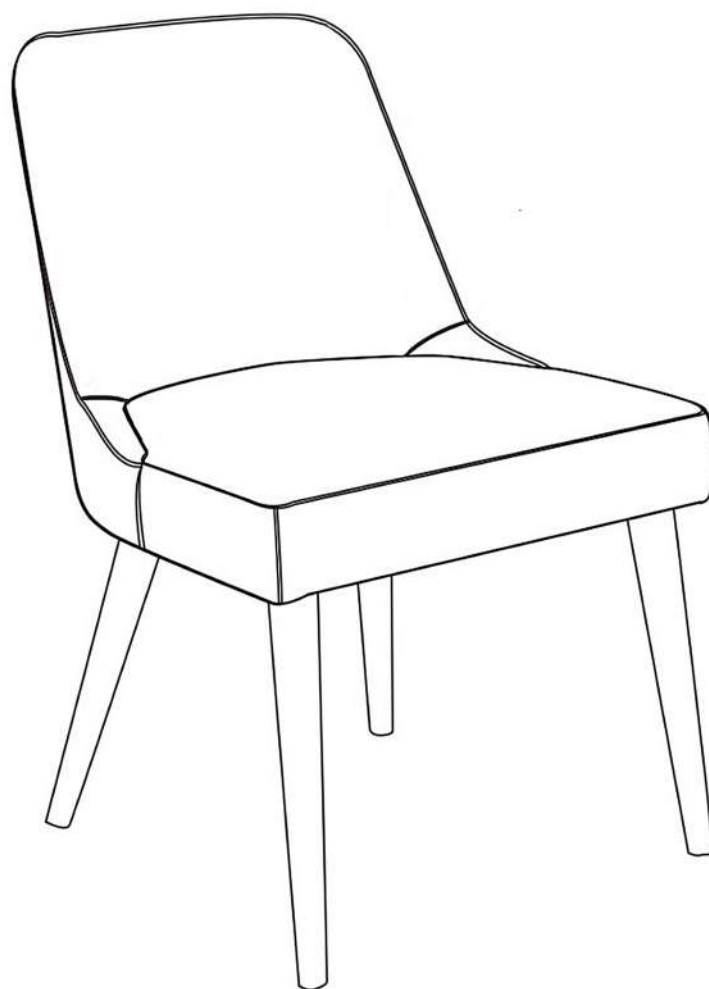

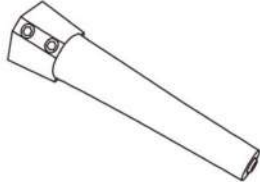

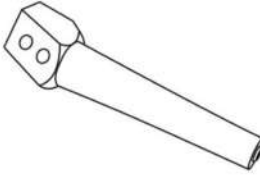

## Assembly Manual for KF.Y1093 Dining Chair



### **CAUTION**

THIS ASSEMBLY MANUAL CONTAINS IMPORTANT SAFETY INFORMATION.  
PLEASE READ AND KEEP FOR FUTURE REFERENCE.

PAR	DRAWING		QTY
A		FRONT LEGS(L/R)	2
B		REAR LEGS(L/R)	2
C		CHAIR BODY	1
D		LONG ALLEN BOLT	8
E		LARGE FLAT WASHER	8
F		SPRING WASHER	8
G		ALLEN KEY	1

STEP 1 Unzip the bottom of the chair seat to remove the legs and hardware.

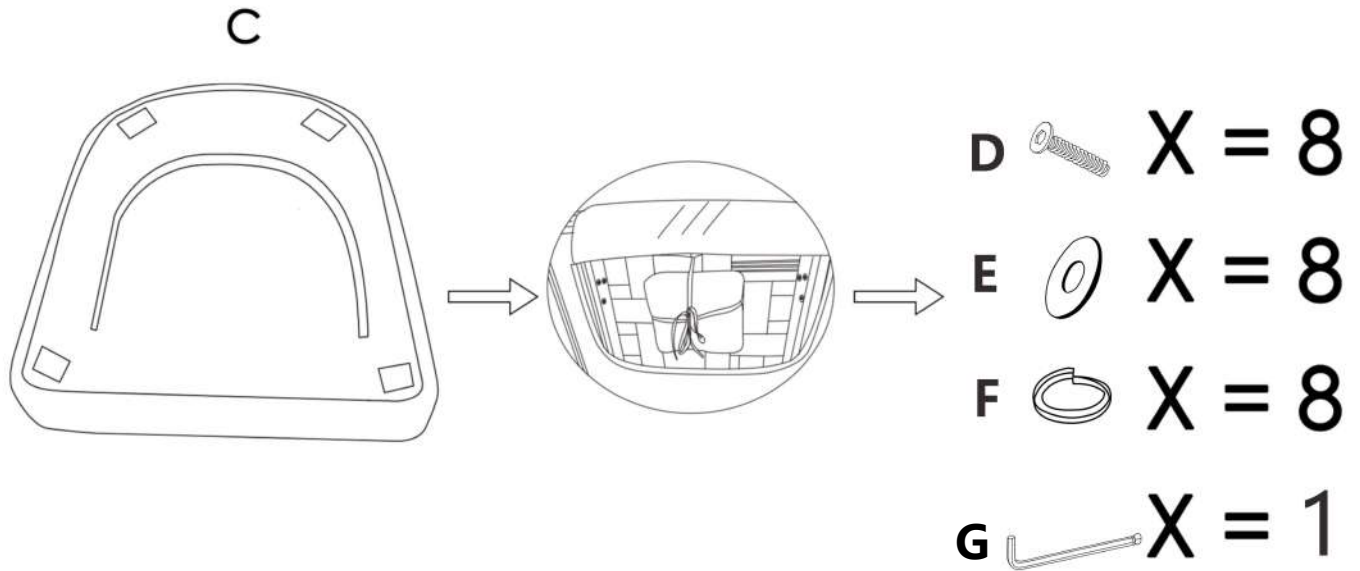

STEP 2 Insert legs in the bottom of the chair seat as shown. Insert large bolts and tighten legs securely. (note: do not mix the position of leg A and leg B.)

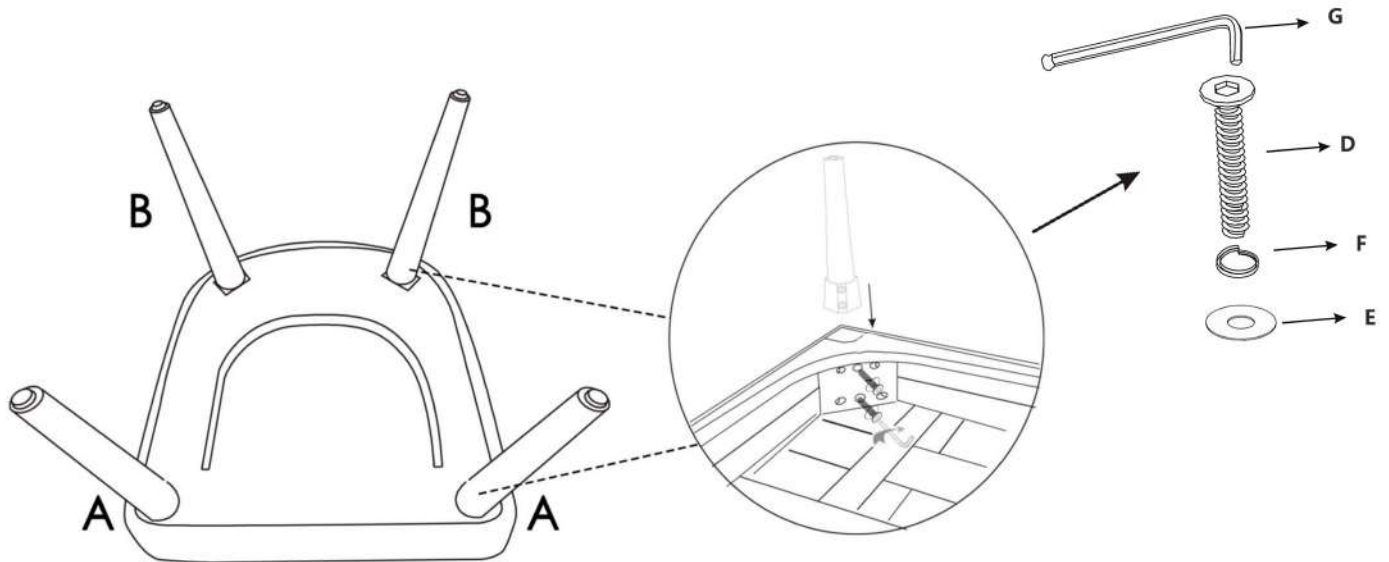

STEP 3 Assembly Complete.

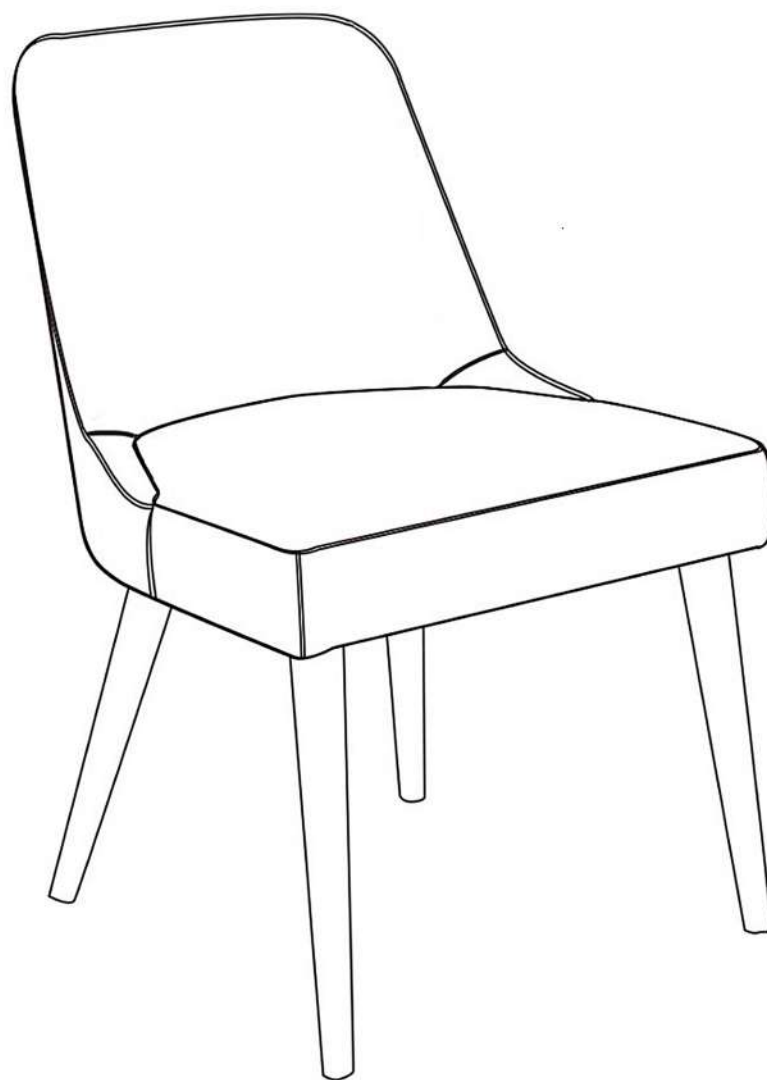

## PRODUCT WARRANTY

- 1-year limited on cover against splitting, peeling, and/or tearing.
- 1-year limited on internal and external frame structure.
- 1-year limited on cushioning material, seat springs and mechanism

## CARE & MAINTENANCE

Water Based Cleaner 'W': Spot clean using the foam only from a water-based cleaning agent such as a mild detergent or non-solvent upholstery shampoo product. Apply foam with a soft in circular motion.

Vaccum when dry.

Do not place furniture in direct sunlight and keep furniture at least 60 cm / 2 feet from heat sources to avoid fading.

## Follow Us



@chitalivingofficial



@chitaliving



@chitaliving



@chitaliving

---

If at any step you need a helping hand, we're always here for you. You can email us, or hop into a live chat on our website - whatever method is convenient for you.



support@chitaliving.com