

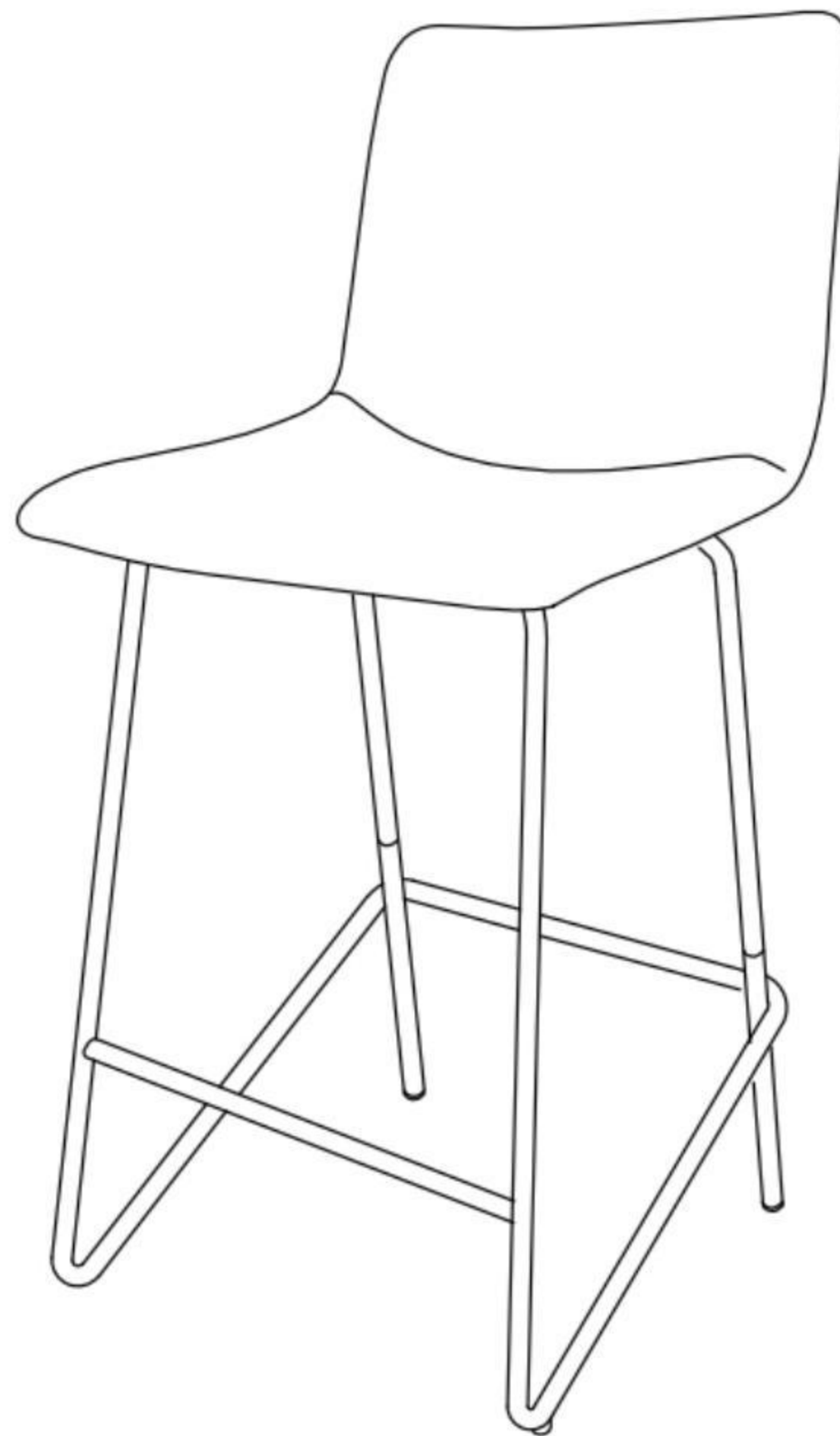





Assembly Manual for KF-Y2003 Counter & Bar Stool

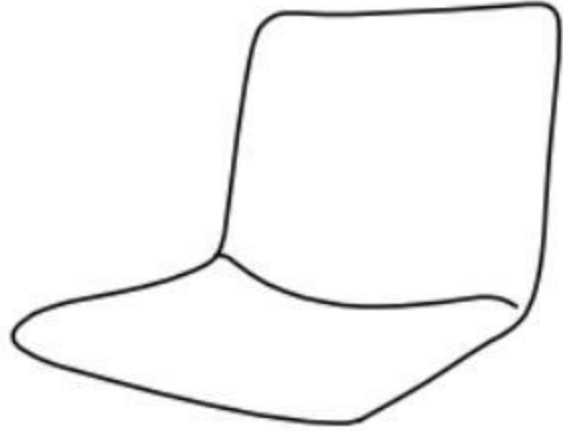

 **CAUTION**

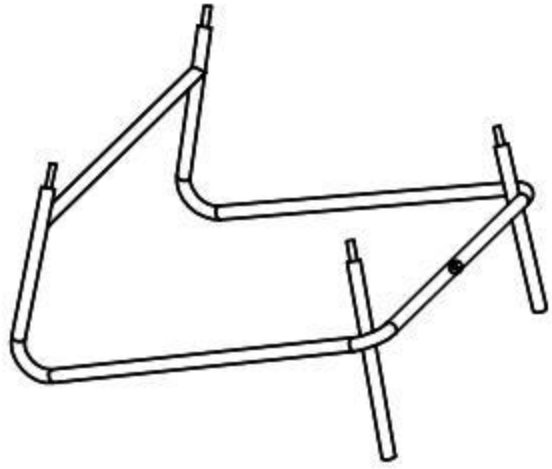
THIS ASSEMBLY MANUAL CONTAINS IMPORTANT SAFETY INFORMATION.

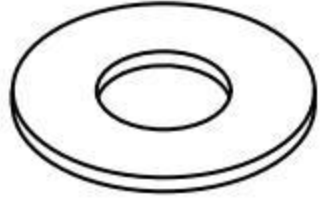
PLEASE READ AND KEEP FOR FUTURE REFERENCE.

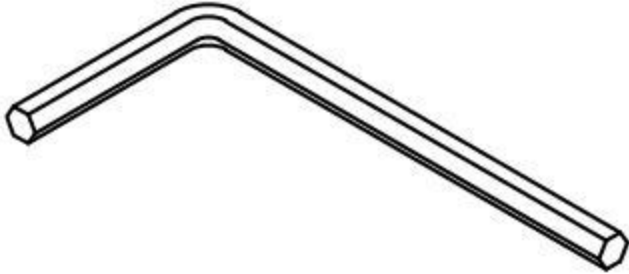
<p>Ax1</p> 	<p>Bx1</p> 	<p>Cx1</p> 
<p>Dx4</p>  <p>M6 x 28mm</p>	<p>Ex6</p>  <p>M6 x 8mm</p>	<p>Fx4</p>  <p>M6</p>
<p>Gx4</p>  <p>M6</p>	<p>Hx1</p>  <p>4#</p>	

Please read through the instructions below to familiarize yourself with the parts and steps before assembly.

ASSEMBLY INSTRUCTIONS

- ① Unpack and place seat (A), upper leg (B) and lower leg (C) on a clean surface.
Please locate the arrow stickers on upper leg (B) and lower leg (C), and make sure they are on one side when assembled.

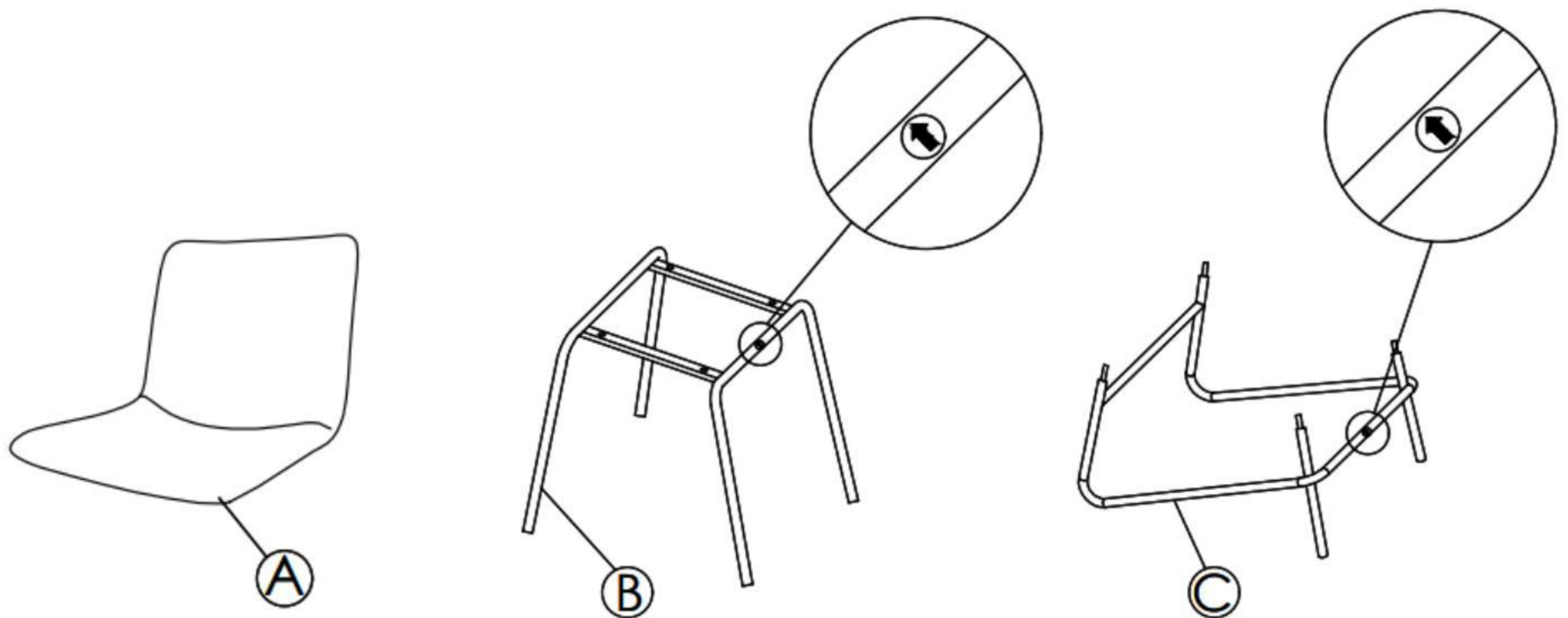

- ② Slide the **back** legs of B into C.

- ③ Slide the **front** legs of B into C.

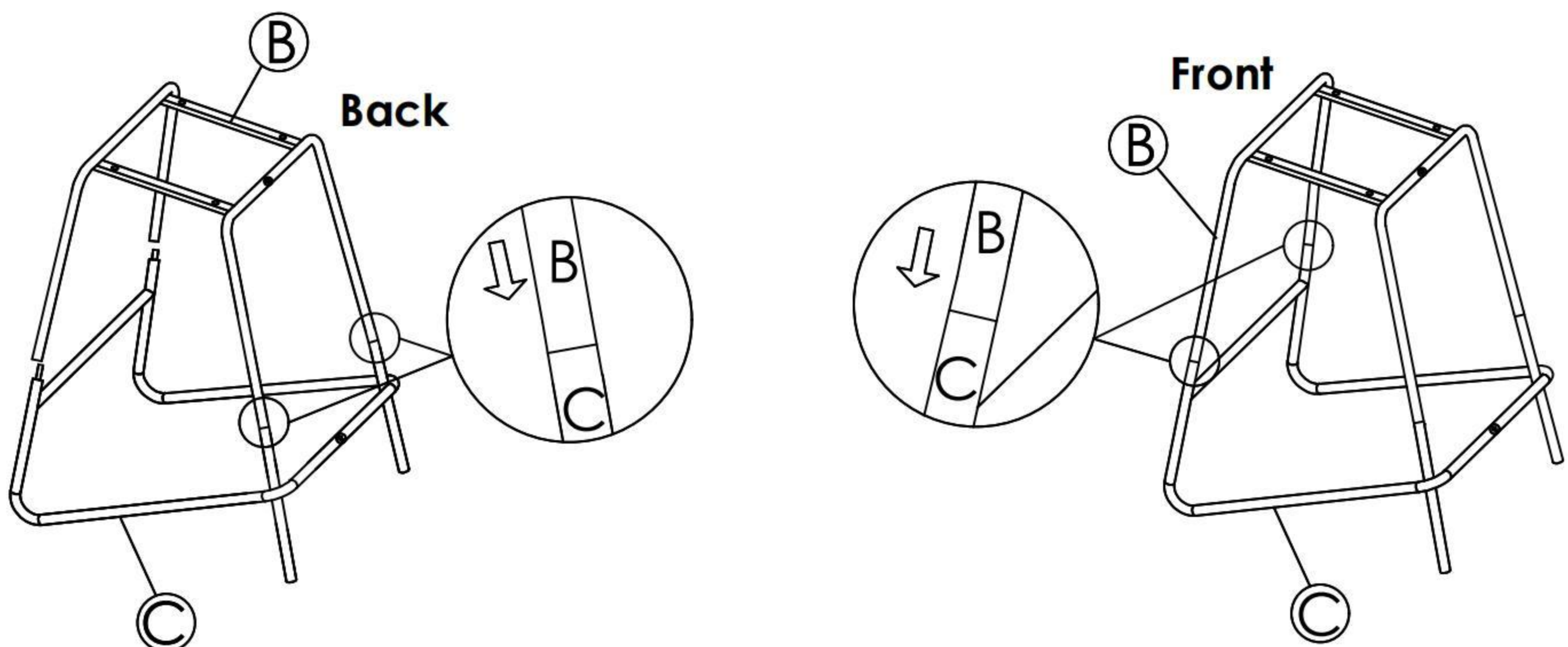

- ④ Attach upper leg (B) to lower leg (C), using shorter bolts (E), and allen wrench (H).
Note: Do not fully tighten yet.

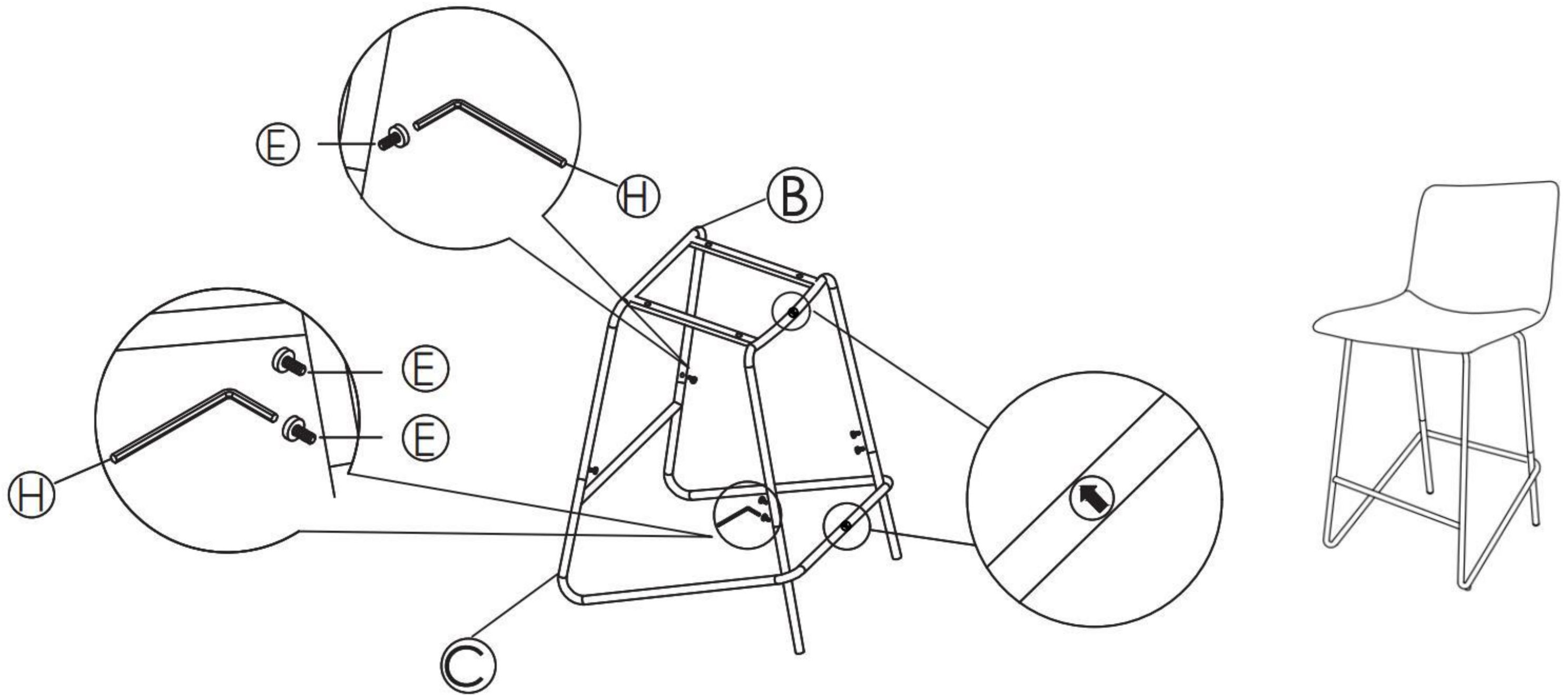

- ⑤ Turn assembled base in step 4 upside down, and attach it to seat (A) using longer bolts (D), lock washers (G), flat washers (F), and allen wrench (H). **Then tighten all bolts.**

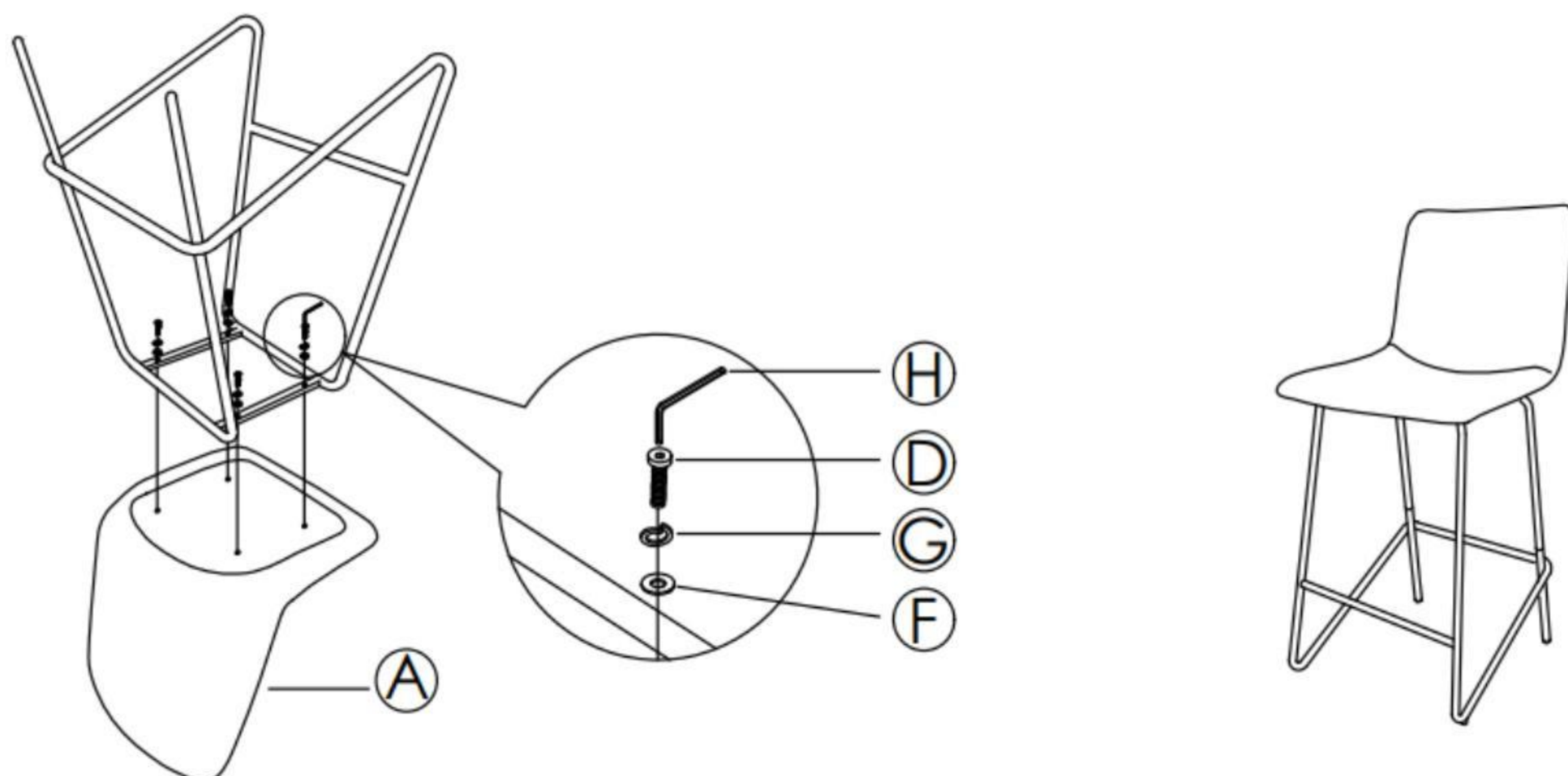

- ⑥ Turn assembled chair upright and place on a flat surface.
Note: Back legs have adjustable foot levelers to help level your chair.

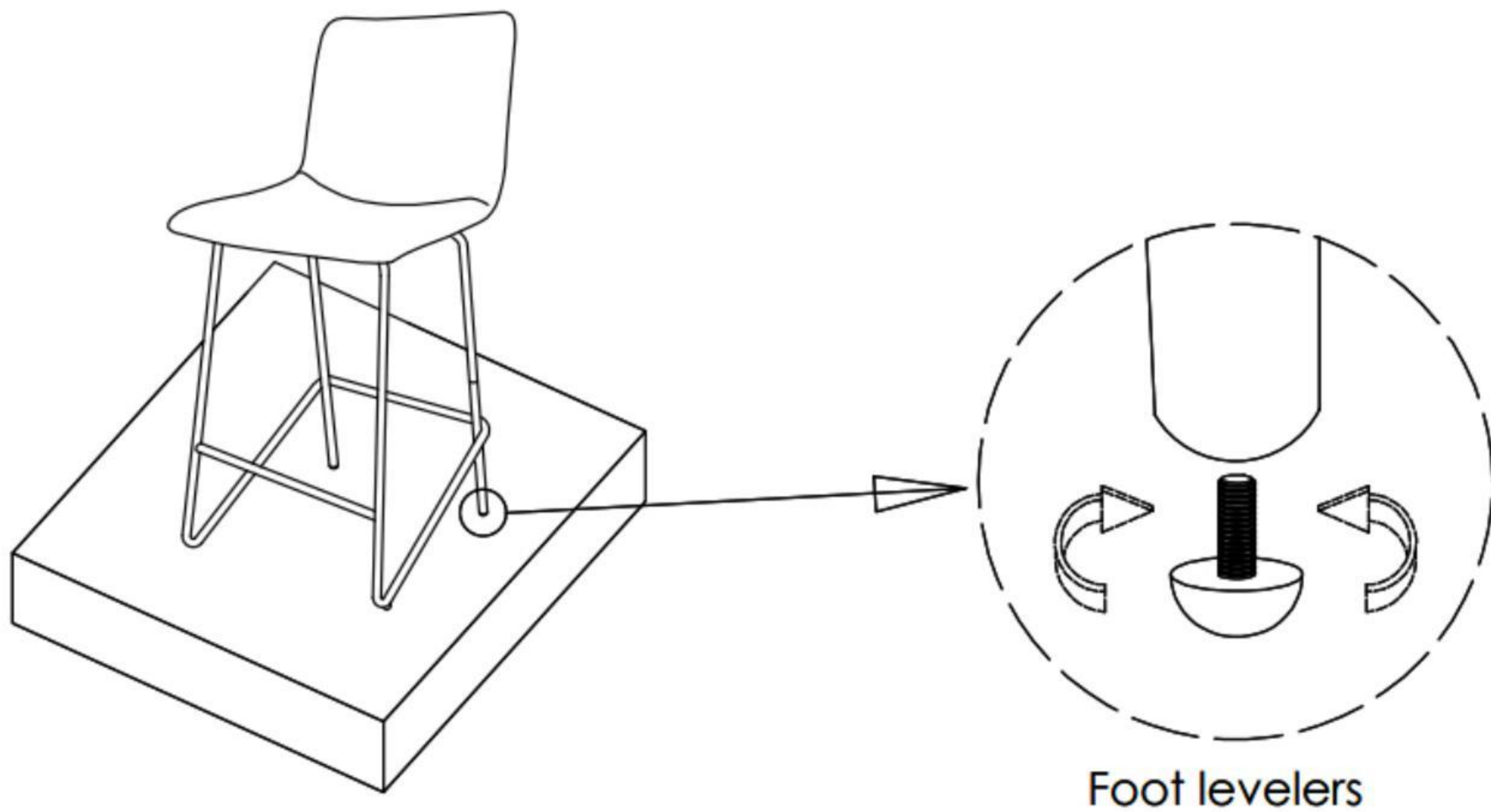

- ⑦ Assembly complete. Enjoy.

